

Hematology Analyzer

Hem-o-test 2000

Operation Manual



BGT BioGenTechnologies GmbH

Von-Langen-Weg 10

D-48565 Steinfurt

Tel.: 02551 / 4090

Fax.: 02551 / 1298

Web: www.biogentechnologies.de

E-Mail: info@biogentechnologies.de

Ver. 03.03.2010

Content

HOW TO USE THE MANUAL	4
SAFETY NOTICE	5
OPERATION NOTICE	6
Chapter 1 INSTRUMENT INTRODUCTION.....	7
1.1 NAME.....	7
1.2 STRUCTURE.....	7
1.2.1 Host	7
1.2.2 Accessory	7
1.3 PURPOSE.....	7
1.4 SPECIFICATIONS	8
1.5 STRUCTURE	11
1.5.1 Front Panel.....	11
1.5.2 Rear panel.....	12
1.6 OPERATION	13
1.6.1 Display Screen	13
1.6.2 Menu.....	13
1.7 DETECTION PRINCIPAL.....	14
1.7.1 Detection Principles of WBC, RBC, PLT	14
1.7.2 Principles of HGB Measurement.....	15
1.7.3 Volume Distribution of Blood Cell.....	15
1.7.4 Results and Calculation of Parameter Measurement	15
Chapter 2 INSTALLATION	16
2.1 PACKING	16
2.2 UNPACKING	16
2.3 INSTALLATION REQUIREMENTS	16
2.3.1 Installation Environment.....	16
2.3.2 Space Requirement.....	17
2.3.3 Power Requirement.....	17
2.4 REAGENT TUBING CONNECTION	17
2.4.1 LYSE CONNECTION	17
2.4.2 DILUENT CONNECTION.....	17
2.4.3 RINSE CONNECTOR	17
2.4.4 WASTE CONNECTOR.....	17
2.5 RECORDER PAPER INSTALLATION	18
2.6 KEYBOARD AND MOUSE INSTALLATION	18
2.7 PRINTER INSTALLATION (OPTIONAL)	18
2.8 BAR CODE SCANNER INSTALLATION (OPTIONAL).....	18
2.9 POWER CABLE CONNECTION	19
Chapter 3 SAMPLE ANALYSIS	20

3.1 PREPARATION BEFORE STARTUP	20
3.2 STARTUP	20
3.3 BACKGROUND TEST	20
3.4 QUALITY CONTROL	21
3.5 PREPARATION FOR SAMPLE COLLECTION	21
3.5.1 Venous Blood Collection	21
3.5.2 Capillary Blood Collection	21
3.5.3 Prepare Samples in Prediluted Mode	22
3.5.4 Prepare Samples in Capillary Mode	22
3.5.5 Sample Homogenization	22
3.6 SAMPLE COUNT AND ANALYSIS	22
3.6.1 Input Sample Information	22
3.6.2 Procedures of Sample Count and Analysis	24
3.6.3 Parameter Alarm	24
3.6.4 Histogram Alarm	24
3.7 ANALYTICAL RESULTS MODIFICATION	24
3.8 SHUTDOWN	25
Chapter 4 QUALITY CONTROL	26
4.1 EDIT QUALITY CONTROL FILES	26
4.2 QUALITY CONTROL RUN	27
4.3 QUALITY CONTROL GRAPH	27
4.4 QUALITY CONTROL TABLE	28
Chapter 5 CALIBRATION	30
5.1 MANUAL CALIBRATION	30
5.1.1 Background Test	30
5.1.2 Assurance of Repeatability	30
5.1.3 Calculate Calibration Factors	31
5.1.4 Modify the Calibration Coefficient	31
5.2 AUTO CALIBRATION	32
Chapter 6 SETTING	34
6.1 DATE & TIME	34
6.2 PRINTOUT	34
6.3 CONFIG	35
6.4 LIMITS	36
6.5 DEPARTMENT	37
6.5.1 Add Record Information	37
6.5.2 Modify Department Information	38
6.5.3 Delete department information	39
6.5.4 Print Department Information	39
6.6 OPERATOR INFORMATION	39
6.6.2 Modify Operator Information	40
6.6.3 Delete operator Information	41
6.6.4 Print Operator Information	41

Chapter 7 REVIEW.....	42
7.1 SAMPLE REVIEW	42
7.2 DETAIL REVIEW.....	44
Chapter 8 SERVICE.....	46
8.1 FLUSH	46
8.2 ENHANCED FLUSH.....	46
8.3 CLEANING.....	46
8.4 ENHANCED RINSE.....	46
8.5 DRAIN CHAMBERS	46
8.6 PARK.....	46
8.7 PRIME DILUENT	46
8.8 PRIME LYSE.....	46
8.9 PRIME RINSE.....	46
8.10 MAINTENANCE.....	46
8.11 MECHANIC	46
8.12 Special	47
Chapter 9 MAINTENANCE.....	48
9.1 ROUTINE MAINTENANCE.....	48
9.1.1 Clean the Appearance.....	48
9.1.2 Replace Fuse	48
9.2 DAILY MAINTENANCE.....	48
9.3 WEEKLY MAINTENANCE	48
9.4 MONTHLY MAINTENANCE.....	49
9.5 YEARLY MAINTENANCE	49
9.6 MAINTENANCE BEFORE TRANSPORT OR FOR THE INSTRUMENT THAT WILL NOT BE USED FOR A LONG TIME.....	49
CHAPTER 10 TROUBLESHOOTING	50
10.1 ABNORMAL STARTUP.....	50
10.2 WASTE FULL.....	50
10.3 DILUENT EMPTY	50
10.4 LYSE EMPTY.....	50
10.5 RINSE EMPTY.....	50
10.6 WBC CLOG OR RBC CLOG.....	50
10.7 WBC BUBBLES OR RBC BUBBLES	50
10.8 HGB ERROR	51
10.9 HGB BUBBLES.....	51
10.10 RECORDER OUT OF PAPER.....	51
10.11 RECORDER TOO HOT	51
10.12 THE RESULT OF BACKGROUND TEST TOO HIGH.....	51
CHAPTER 11 HELP	52
Appendix 1: SYMBOL.....	53

HOW TO USE THE MANUAL

You are welcome to read this manual. This manual includes the in-depth information about installation, daily operation, calibration, quality control and maintenance. To achieve the optimal performance, be sure to operate and maintain the instrument according to this manual. If you have chosen the optional accessories such as printer, Bar Code Scanner, read the related manuals of those.

The data in this manual has been calibrated and is efficient. If the instrument is used in special purpose, or the operational procedures/methods exceed the regulation of this manual, please contact with BGT BioGenTechnologies GmbH to inquire its validity and applicability. Otherwise BGT BioGenTechnologies GmbH will not be able to ensure the accuracy and validity of the measuring results, and will not perform any obligation for the direct or indirect results resulting from this action.

AVOIDANCE FROM POTENTIAL HAZARD:

User should read the Safety Notice and Operation Notice carefully.

There are several safety warning signs in this manual to help operators avoid hurting themselves or making the instrument damaged, resulting in incorrect measuring results:

Warning: The instrument must be operated as the operating procedures, or else, there will be great hazards to both operator and environment.

Caution: Emphasize the operating methods that must be obeyed. Avoid potential hazard or making the instrument damaged, resulting in incorrect measuring results.

Notice: To emphasize important information.

All personnel that may operate, maintain, remove, service the instrument should read this manual carefully.

Hereinafter called Hem-o-test 2000 hematology analyzer as instrument.

Hereinafter called BGT BioGenTechnologies GmbH. as BGT.

SAFETY NOTICE

To operate the Instrument safely and effectively, be sure to read the following notices first. Operating the instrument, without following the appointed methods by the manufacturer, may break down the defensive function of the system, and cause bodily injury or damage the instrument.

- **Avoid electric shock**

(1) When the power-on, the unauthorized maintenance personnel should not pen the instrument.

(2) If liquid enters into the instrument or the instrument leakage, please shutoff the power immediately, and contact with BGT Customer Service Department or ocal distributor in due course. Improper use of the liquid may cause electric shock and result in damaging the instrument.

- **Defence for biohazrd and chemical hazards**

Improper use of the sample may result in being infected.

Avoid hand touch the sample, reagent and waste directly. When operate the instrument, be sure to wear gloves to avoid being infected.

If the skin touched the sample, manage it according to operator working standard or inquiring a doctor to take remedial measures immediately.

Use the reagent carefully to avoid hand and clothes touch directly.

Once hand or clothes touch, flush the touched area with soap and plenty of water immediately.

- **Waste disposal**

If the reagent enters into the eyes incautiously, flush with plenty of water at once, and inquire a doctor for further treatment.

Reagent, quality control serum, some materials in the sample are controlled by Pollution Regulations and Standard for Discharge of Pollutants. Please abide by the local discharge regulation and inquire related reagent manufacturer.

- **Prevention of fire and explosion**

Be sure not to use flammable dangerous materials around the instrument.

OPERATION NOTICE

To operate the instrument safely and reliably, be sure to obey the following notices.

- **Purpose**
Pay attention to the application range of the instrument statement. Make sure your use does not exceed the application range.
- **Limitation of operating environment**
- The instrument should be installed according to the required installation environment of the manual. Installation and use out of the appointed range may cause unreliable results, and make the instrument damaged.
- Contact with BGT Customer Service Department or local distributor if you need to change the state of the instrument.
- **Limit of Operator**
Only trained and authorized personnel by the manufacturer can operate the instrument.
- **Maintenance and Service**
Be sure to service and maintain the instrument according to this manual strictly.

Chapter 1 INSTRUMENT INTRODUCTION

1.1 NAME

The full name of the instrument is Hem-o-test 2000.

1.2 STRUCTURE

Host and accessory.

1.2.1 Host

Control the process of sample collection, dilution and analysis, including the following units:

1. Power Supply unit.
2. Central control circuit unit.
3. Dilute unit
4. Volumetric unit.
5. Display unit.
6. Thermal recorder.

1.2.2 Accessory

Including the following accessories:

1. PS/2 mouse.
2. PS/2 keyboard.
3. Printer (Optional)
4. Bar code scanner (Optional)
5. Power cord.
6. Ground wire.

1.3 PURPOSE

It is used for detecting the parameters of RBC, WBC, HGB and differential counter.

The analyzer is used for the determination of the following 20 parameters and 3 histograms blood specimens in Table 1-1.

Item	Abbreviation	Unit
White blood cell or leukocyte	WBC	$10^3/\mu\text{l}$
Lymphocyte	LYM#	$10^3/\mu\text{l}$
Mid-sized cell	MID#	$10^3/\mu\text{l}$
Granulocyte	GRAN#	$10^3/\mu\text{l}$
Lymphocyte percentage	LYM%	%
Mid-sized cell percentage	MID%	%
Granulocyte percentage	GRAN%	%
Red Blood Cell or erythrocyte	RBC	$10^6/\mu\text{l}$
Hemoglobin Concentration	HGB	g/dl
Hematocrit	HCT	%
Mean Corpuscular(erythrocyte)Volume	MCV	fL
Mean Cell Hemoglobin	MCH	pg
Mean Cell Hemoglobin Concentration	MCHC	g/dL
Red Blood Cell Distribution Width-Standard Deviation	RDW-SD	fL
Red Blood Cell(erythrocyte) Distribution Width Coefficient of Variation	RDW-CV	%
Platelet	PLT	$10^3/\mu\text{l}$
Mean Platelet Volume	MPV	fL
Platelet Distribution Width	PDW	%
Plateletcrit	PCT	%

Plateletcrit-large Cell Ratio	P-LCR	%
White Blood Cell Histogram	WBC-Histogram	
Red Blood Cell Histogram	RBC-Histogram	
Platelet Histogram	PLT-Histogram	

1.4 SPECIFICATIONS

- **Standard Classification of the Instrument**
According to anti-electrical shock hazard: Grade II, Pollution 2
According to the defence for deleterious liquid: General Device(Closing device of non-defensive liquid)
According to the recommended disinfection/sterilization method of the manufactory:
Disinfectant device recommended by manufactory.
According to safety degree in condition that using gas mixture of flammable anesthetic gas and air or gas mixture of oxygen and nitrous oxide: Do not use the equipment in condition that using gas mixture of flammable anesthetic gas and air or gas mixture of oxygen and nitrous oxide.
According to working status: Continuous Running Equipment.
- **Principles of Measurement**
Blood Cells are counted and sized by Electrical Impedance Method. Hemoglobin is determined by Colorimetry Method.
- **Parameters of Measurement**

Basic parameters:

Item	Abbreviation	Unit
White blood cell	WBC	$10^3/\mu\text{l}$
Red Blood Cell	RBC	$10^6/\mu\text{l}$
Hemoglobin Concentration	HGB	g/dl
Platelet	PLT	$10^3/\mu\text{l}$

Derived from Histograms:

Item	Abbreviation	Unit
Lymphocyte percentage	LYM%	%
Mid-sized cell percentage	MID%	%
Granulocyte percentage	GRAN%	%
Mean Corpuscular(erythrocyte)Volume	MCV	fL
Red Blood Cell Distribution Width-Standard Deviation	RDW-SD	fL
Red Blood Cell(erythrocyte) Distribution Width Coefficient of Variation	RDW-CV	%
Mean Platelet Volume	MPV	fL
Platelet Distribution Width	PDW	%
Plateletcrit-large Cell Ratio	P-LCR	%

Calculated Parameters:

Item	Abbreviation	Unit
Lymphocyte	LYM#	$10^3/\mu\text{l}$
Mid-sized cell	MID#	$10^3/\mu\text{l}$
Granulocyte	GRAN#	$10^3/\mu\text{l}$
Hematocrit	HCT	%
Mean Cell Hemoglobin	MCH	pg
Mean Cell Hemoglobin Concentration	MCHC	g/dL
Plateletcrit	PCT	%

- **Sampling Features:**

Sample Volume:

Venous Blood Mode: 9.6-L Venous Blood

Capillary Blood Mode: 9.6-L Capillary Blood
 Prediluted Mode: 20-L Capillary Blood

Reagent Volumes Required for Single Sample:

Diluent: 20mL
 Rinse: 4mL
 Lyse: 0.35 mL

Venous and Capillary Blood Mode: WBC/HGB 1:300
 RBC/PLT 1:44600

Prediluted Mode: WBC/HGB 1:355
 RBC/PLT 1:44500

Cell Counting Aperture Size:

WBC/RBC/PLT: 80-m

- **Display**

Liquid Crystal Display (LCD), resolution: 640x480

- **Language**

English

- **Indicator**

20 Parameters and 3 Histograms Display

Alarm Indicator

Working Status (including Power) Indicator Light

Alarm

- **Interface**

One power input socket

One printer port

Two RS232/C serial ports

Two USB interfaces

Two PS/2 interfaces

- **Recorder**

Rapid Thermal Recorder

Recording width: 48mm

Paper width: 57.5mm

Precision Specifications of the Instrument

Parameter	Repeatability (CV %)
WBC	≤ 3.0 %
RGB	≤ 3.0 %
HGB	≤ 3.0 %
MCV	≤ 3.0 %
PLT	≤ 7.0 %

Linear Range

Parameter	Linear Range
WBC	0.0 – 99.9 x 10 ³ /μL
RGB	0.00 – 99.9 x 10 ⁶ /μL
HGB	0 – 30 g/dL
MCV	40 – 150 fL
PLT	0 – 999 x 10 ³ /μL

Screen Display and the Ranges for Report Output Parameters

Parameter	Parameter Range	Parameter	Parameter Range
WBC	0.0 – 99.9 x 10 ³ /μL	GRAN#	0 – 99.9 x 10 ³ /μL
RGB	0.00 – 99.9 x 10 ⁶ /μL	HCT	0 – 100 %
HGB	0.0 – 30 g/dL	MCH	0.0 – 999.9 pg
PLT	0 – 3000 x 10 ³ /μL	MCHC	0.0 – 99.9 g/dL
MCV	0 – 250 fL	RDW-SD	0.0 – 99.9 fL
LYM%	0 – 100 %	RDW-CV	0.0 – 99.9 %
MID%	0 – 100 %	PDW	0.0 – 30.0 %
GRAN%	0 – 100 %	MPV	0.0 – 30.0 fL
LYM#	0 – 99.9 x 10 ³ /μL	PCT	0.0 – 9.99 %
MID#	0 – 99.9 x 10 ³ /μL	P-LCR	0.0 – 99.9 %

- **Operating Ambient**

Temperature: 18k~35k
Humidity: ,70%
Atmospheric Pressure: 86.0kPa ~106.0kPa

- **Ambient Storage**

Temperature: -10k~40k
Humidity: ,80%
Atmospheric Pressure: 50.0kPa ~106.0kPa

- **Electric Specifications**

Power Supply: AC 220(1f10%)V, 50f1Hz,
The maximum input consumption is 150VA
Fuse: AC 250V 2A

- **Dimensions and Weight**

Dimensions: 325mm×380mm×430mm
Weight: 23kg

1.5 STRUCTURE

1.5.1 Front Panel

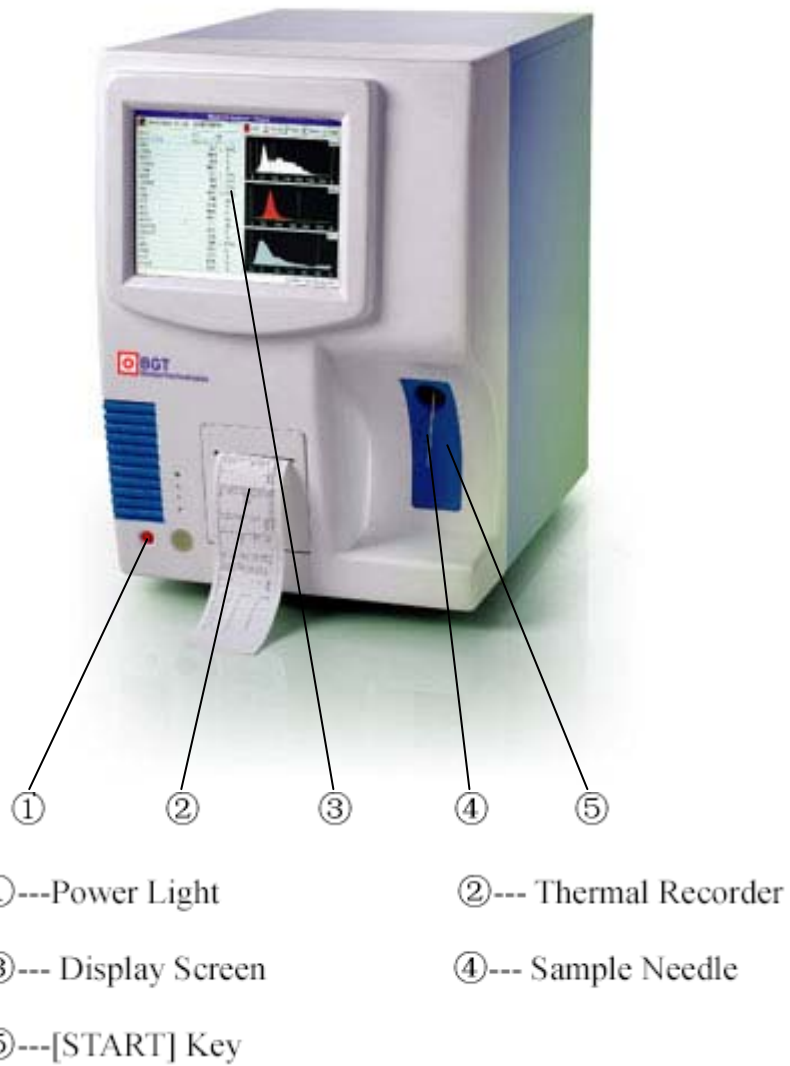

1.5.2 Rear panel

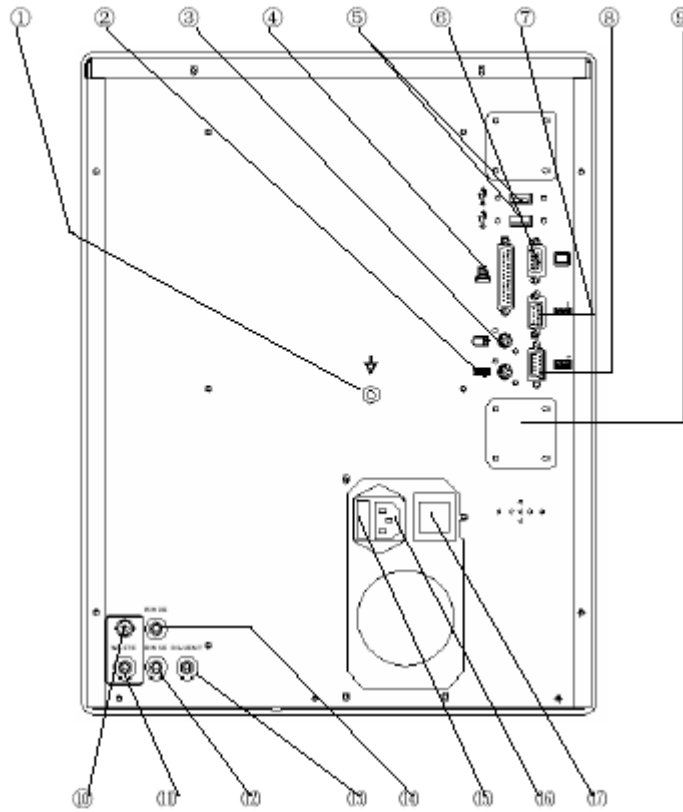

Figure 1-2

- | | |
|---------------------------|-----------------------------|
| ①---Equipotentiality | ②---PS/2 Keyboard Interface |
| ③--- PS/2 Mouse Interface | ④---Printer Interface |
| ⑤---USB Serial Interface | ⑥--- Spare Interface |
| ⑦---RS-232 Serial Port 1 | ⑧--- RS-232 Serial Port 2 |
| ⑨---Air Filter | ⑩--- WASTE Sensor Connector |
| ⑪--- WASTE Connector | ⑫--- RINSE Connector |
| ⑬--- DILUENT Connector | ⑭---LYSE Connector |
| ⑮--- Fuse Holder | ⑯--- Socket for Power Input |
| ⑰--- Power Switch | |

1.6 OPERATION

Designed according to human engineering and transferring information to users by software windows and mouse, both are convenient for your operating.

1.6.1 Display Screen

The display screen is classified five sections:

SYSTEM TIME SECTION	INFORMATION SECTION	SHORTCUT KEY SECTION
WINDOWS DISPLAY SECTION		
AUXILIARY OPERATION SECTION		

Figure 1-3

- **SYSTEM TIME SECTION**
Display the current date and time of the system.
- **INFORMATION SECTION**
Display prompt information of the system.
- **SHORTCUT KEY SECTION**
To display the function interfaces of the system.
- **WINDOWS DISPLAY SECTION**
Display various results.
- **AUXILIARY OPERATION SECTION**
Display the information of user.

1.6.2 Menu

You can operate the instrument by menu. Press the right key of the mouse, directing to the function menu of the current window. Move the mouse to the required menu bar, and then press the left key of the mouse, the required function will be selected. Pressing the left key out of the menu area, the operation will be canceled. The common functions are showed at the top right corner of the screen as shortcut key. Move the mouse to the function you wanted.

The menu functions are as follows:

Sample Mode: Choose the sample mode among Venous Blood Mode, Capillary Blood Mode and Prediluted Mode.

Diluent: Inject the diluent quantitatively by sample needle. This menu uses only in Prediluted Mode.

Information: Enter the information window of the next sample, input and modify the information.

Histogram: Enter the histogram adjustment window of the current sample. You can manually adjust the histograms of the current sample.

Print: Output the data of the current sample to the appointed device.

Function: Enter the function menu.

Mute: Stop the alert.

Help: Access the system help window.

About: Display information of the instrument such as software and copyright etc.

Shutdown: Startup the shutdown program to rinse the measurement unit automatically.

Shutoff the power supply when the screen displays "Turn off the power now".

Review: Enter the review window. You can review, inquire or modify the measurement data of the former sample.

Calibration: Enter the calibration window to calibrate the instrument.

Quality Control: Enter the quality control window to carry out quality control operation.

Setting: Enter the setting menu.

Service: Enter the service menu.

Manual Calibration: Enter the manual calibration window to calibrate the instrument manually.

Auto Calibration: Enter the auto calibration window to adjust the instrument automatically.

QC Edit: Enter the QC edit window to edit the QC parameters.

QC Run: Enter the QC run window to carry out the selected QC files.

QC Graphs: Enter the QC graphs window to browse the selected QC graphs.

QC Table: Enter the QC table window to browse the selected QC tables.

Time: Enter the time setting window to set the time of the instrument.

Printout: Enter the printout window to set the functions such as print or report.

Config: Enter the config window to set the functions such as print, sleep, clean, and display etc.

Limits: Enter the limits window to modify the limits.

Department: Enter the department window to set the department and abbreviation.

Operator: Enter the operator window to set the department, abbreviation, department and operator.

Flush: To get rid of the aperture clog.

Enhanced Flush: To get rid of hard aperture clog.

Cleaning: Run the normal rinse process to rinse the measurement unit.

Enhanced Cleaning: Rinse the measurement unit with RINSE.

Drain Chambers: Empty the liquid of the counter pool.

Park: Run the Park Program to rinse and empty the tubing.

Prime Diluent: Inject the Diluent to the appointed tubing.

Prime Lyse: Inject the Lyse to the appointed tubing.

Prime Rinse: Inject the Rinse to the appointed tubing.

Maintenance: Run the maintenance program to maintain the instrument.

Mechainc: Enter the Mechainc window to verify the functions of the instrument.

Special: Enter the Special window to maintain the instrument.

1.7 DETECTION PRINCIPL

1.7.1 Detection Principles of WBC, RBC, PLT

The count principle of the instrument is based on the measurement of changes in electrical resistance produced by a particle passing through an aperture sensor.

- a) The sample blood is diluted in a conductive liquid. As blood cells are non-conductive, the diluent is a good conductor. There are big differences between them.
- b) When the diluent passes through the aperture sensor, electrodes are submerged in the liquid on each side of the aperture to create continuous current.
- c) When cells pass through the aperture, the resistance between the electrodes increases as the cell volume increasing, as shown in figure 1-4. According to the Ohm Formulary: $U=RI$ (U =Voltage I =Current R =Resistance). If I is a constant, U increases as the cell volume increasing.
- d) Passing through the magnification circuit, the voltage signal will be magnified and the noise will be filtered, then you will gain the analytical results, as shown in figure 1-4.
- e) One count bath and the detection circuit count the WBC. Another count bath and the detection circuit count the RBC and PLT. The microprocessor of the instrument calculates and analyzes the cells (WBC, RBC, PLT), and then gives out the histograms.
- f) PLT count adopts advanced liquid, electronics and software system. It settles the repetitive count of the cells on the side of the aperture count area.

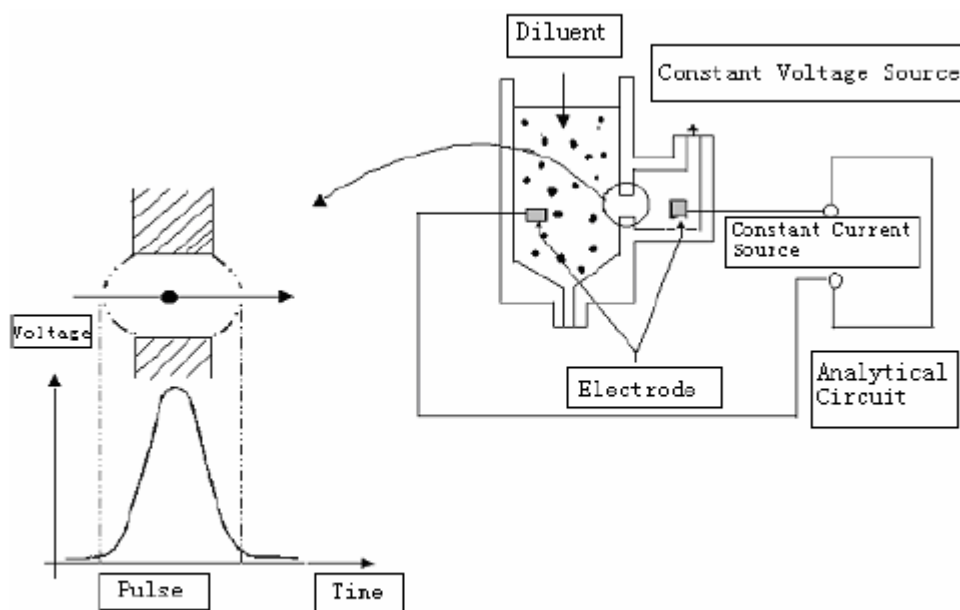

Figure 1-4

1.7.2 Principles of HGB Measurement

Adding lyse in the blood, the red blood cell will rapidly be broken down and release hemoglobin. Hemoglobin and lyse form a new mixture, which can absorb the wavelength of 540nm. Measure the absorbency. Through the comparison of the absorbency between the pure diluent and the sample, the concentration of the sample hemoglobin is calculated.

1.7.3 Volume Distribution of Blood Cell

When different types of cells pass through the aperture sensor, there will be different electrical pulse height. Because of the evident difference of the cells sizes, the instrument is able to differentiate the white blood cell, red blood cell and platelet by its pre-set program.

The volume distributions are as follows:

W BC	120_1000fL
RBC	82_98fL
PLT	2_35fL

The leucocytes disposed by lyse can be divided into three types, according to their volumes:

lymphocyte (LYM), mid-sized cell (MID), Granulocyte (GRAN).

LYM	35_90 fL
MID	90_160 fL
GRAN	160_450 fL

1.7.4 Results and Calculation of Parameter Measurement

The parameters of the sample blood test can be described in three ways:

- Measured directly, such as WBC, RBC, PLT, and HGB.
- Derived from histograms, such as LYM%, MID%, GRAN%, MCV, RDW-SD, RDW-CV, MPV, PDW, P-LCR.
- Calculated, such as LYM#, MID#, GRAN#, HCT, MCH, MCHC, PCT.

The derivation of the formularies as follows:

- MCV derives from histograms and the instrument collecting and classifying the erythrocytes according to its volume. It is determined by measuring the average volume of individual erythrocytes,

- and the unit is fL.
- RDW represents the volume distribution of the erythrocyte populations, derived from the RBC histogram. It can be expressed by the coefficient variation of the erythrocyte volume as RDW-CV, and the unit is %. It can also be expressed in standard deviation of the erythrocyte volume as RDW-SD, the unit is fL.
 - MPV is the average volume of individual platelets, derived from the PLT histogram. It represents the mean volume of the PLT populations and can be expressed in fL.
 - PDW derives from the PLT histogram. It represents the geometry standard deviation (10 GSD) of the volume of the PLT populations.
 - P-LCR derives from the PLT histogram. It represents the ratio of the larger PLT and the unit is %.
 - $HCT(\%) = RBC \times MCV / 10$
 - $MCH(\text{pg}) = 10 \times HGB / RBC$
 - $MCHC(\text{g/L}) = 100 \times HGB / HCT$
 - $PCT(\%) = PLT \times MPV / 10$
 - $LYM\% = 100 \times AL / (AL + AM + AG)$
 - $MID\% = 100 \times AM / (AL + AM + AG)$
 - $GRAN\% = 100 \times AG / (AL + AM + AG)$
 - $LYM\# = LYM\% \times WBC / 100$
 - $MID\# = MID\% \times WBC / 100$
 - $GRAN\# = GRAN\% \times WBC / 100$

AL: Number of cells in LYM area;

AM: Number of cells between lymphocyte and granulocyte area;

AG: Number of cells in GRAN area.

Chapter 2 INSTALLATION

2.1 PACKING

If packing damage is discovered after receiving the instrument, or the instrument is badly damaged, contact with the freight agent immediately to file a claim according to the damage level. At the same time contact with your supplier to make sure the packing is complete. Then unpacking and installing the instrument as the following steps.

2.2 UNPACKING

Take out the instrument and accessories from the packing case carefully. Preserve the packing material for future transportation or storage.

- a) Check the accessories compared to the packing list.
- b) Check whether there are mechanical damages on the instrument and accessories
If there is any problem, please recovery the packing and contact with your supplier immediately.

2.3 INSTALLATION REQUIREMENTS

2.3.1 Installation Environment

The instrument should be placed on a clean steady room platform. Avoid direct sunlight and dust. Keep room temperature at 18~35°C, humidity no higher than 70%, atmospheric pressure at 86.0~106.0Kpa.

Caution:

The instrument should avoid direct sunlight.

Caution:

The working environment of the instrument should avoid powerful equipment such as Centrifuge, CT machine, NMR equipment, X-ray machine etc.

Caution:

Do not use equipment that may create strong radiation field such as mobile phone and cordless telephone. Strong radiation field will disturb some functions of the instrument.

2.3.2 Space Requirement

At least 20cm on each side is the preferred access to ensure good airiness.

Notice:

Reagents must be placed at the same working height as the instrument.

2.3.3 Power Requirement

The power requirement as follows:

- AC 220(1±10%)V, 50 Hz
- The maximum power consumption is 150VA

Warning:

The instrument requires a single well-grounded power socket. Its grounding voltage is no more than 0.5V.

Warning:

A grounded outlet is required to connect with the grounding pole on the rear panel. Be sure to guarantee the reliability of the power grounding at working site.

Caution:

Fluctuating electric will badly decrease the performance and reliability of the instrument. Proper action such as the installation of UPS (self-preparation) should be taken before use.

2.4 REAGENT TUBING CONNECTION

There are four tube connectors with color of black, green, blue, red on the rear panel of the instrument. To avoid tubing contamination, the manufacturer plugs up a cap for each of the connectors before delivery. Please pull the caps out of the connectors carefully before installation for the first time and preserve them.

2.4.1 LYSE CONNECTION

Take out the lyse tube with red connector from the accessory kit.

Connect the red lyse tubing connector with the tubing connector of the same color on the rear panel of the instrument.

Place the other end of the lyse inlet tubing into lyse container, and turn the container cover until secure.

2.4.2 DILUENT CONNECTION

Take out the diluent tube with green connector from the accessory kit.

Connect the green diluent tubing connector with the tubing connector of the same color on the rear panel of the instrument.

Place the other end of the diluent inlet tubing into diluent container, and turn the container cover until secure.

2.4.3 RINSE CONNECTOR

Take out the rinse tube with blue connector from the accessory kit.

Connect the blue rinse tubing connector with the tubing connector of the same color on the rear panel of the instrument.

Place the other end of the rinse inlet tubing into rinse container, and turn the container cover until secure.

2.4.4 WASTE CONNECTOR

Take out the waste tube with black connector from the accessory kit.

Connect the black rinse tubing connector with the tubing connector of the same color.

Connect BNC plug with BNC socket marked "WASTE" on the rear panel of the instrument

Turn the waste container cover clockwise until secure.

Caution:

After completing all the tubing installation, keep the tubing natural state, without distortion, folding, and twist.

Caution:

All the tubing connectors must be installed manually. Forbid using any tool.

Caution:

The reagent must be applied with the instrument. Otherwise it may easily cause inaccurate measurement results and incorrect classification of the blood cell, or make the tubing system badly damaged.

Caution:

Keep the reagent from direct sunlight.

Caution:

After replacing the reagent container, discard the rest of the reagent in the former container. Forbid putting the rest of the reagent into the replacing container. Avoid polluting the new replacing reagent.

Caution:

When replacing the reagent, avoid making the plastic tube (inserted into the reagent container) contact other things. Avoid polluting the new replacing reagent.

Caution:

Avoid using frozen reagent.

Caution:

Avoid using the reagent out of its expiration date.

Warning:

Handle and dispose of the waste according to acceptable laboratory, local state and national standards.

2.5 RECORDER PAPER INSTALLATION

- a) Tear down the gummed paper from the door of the recorder.
- b) Gently press the door of the recorder to open it.
- c) Insert the new paper into the paper entry, and make the printing side towards the thermal head.
- d) When the paper juts out from the other side, pull it out and keep it straight.
- e) Pull the paper out of the paper exit.

2.6 KEYBOARD AND MOUSE INSTALLATION

Take out the keyboard, mouse cushion and mouse from the packing case carefully.

Plug keyboard cable into the interface marked  on the rear panel of the instrument.

Plug mouse cable into the interface marked  on the rear panel of the instrument.

The keyboard and mouse can be placed where it is convenient for your operating. We suggest that the keyboard under the display screen of the instrument, the mouse cushion at the right side of the keyboard, and the mouse on the mouse cushion.

2.7 PRINTER INSTALLATION (OPTIONAL)

Take out the printer from the packing case carefully. Install the printer according to the printer manual.

Notice:

The printer cable can only be connected with the interface marked  on the rear panel of the instrument.

2.8 BAR CODE SCANNER INSTALLATION (OPTIONAL)

Take out the bar code scanner from the packing case. Install the bar code scanner according to the bar code scanner manual.

Notice:

The bar code scanner cable into can only be connected with the interface marked on the rear panel of the instrument.

2.9 POWER CABLE CONNECTION

Make sure the power switch is off (0) on the rear panel of the instrument. Insert one end of the power cable into the power cable interface on the instrument, the other end into the power socket. Connect the ground wire to the grounding port on the instrument.

Warning:

Ensure the power is suitable for the instrument before connection.

Chapter 3 SAMPLE ANALYSIS

3.1 PREPARATION BEFORE STARTUP

Every time before startup, the operator should do the following checks:

- Check whether the diluent and waste tubing are distortion, folding, twist, and whether the connection is secure.
- Check whether the power cable connection is secure.
- Check whether the accessory connection is secure.

3.2 STARTUP

If external printer or bar code scanner is equipped, turn on the printer power or the bar code scanner power and ensure they are in ready status.

Press the power button on the rear panel of the instrument, then the power lamp on the front panel of the instrument lights on. The instrument automatically performs initialization program.

After completing initialization, the instrument will access self-test window. It tests the working conditions of each part and if there is enough diluent, rinse and lyse. Simultaneously prime and clean the tubing.

After self-test, the instrument will access blood cell analyzer window, as shown in Figure 3-1.

If the system detects malfunction, the failure information will be displayed on Information Section.

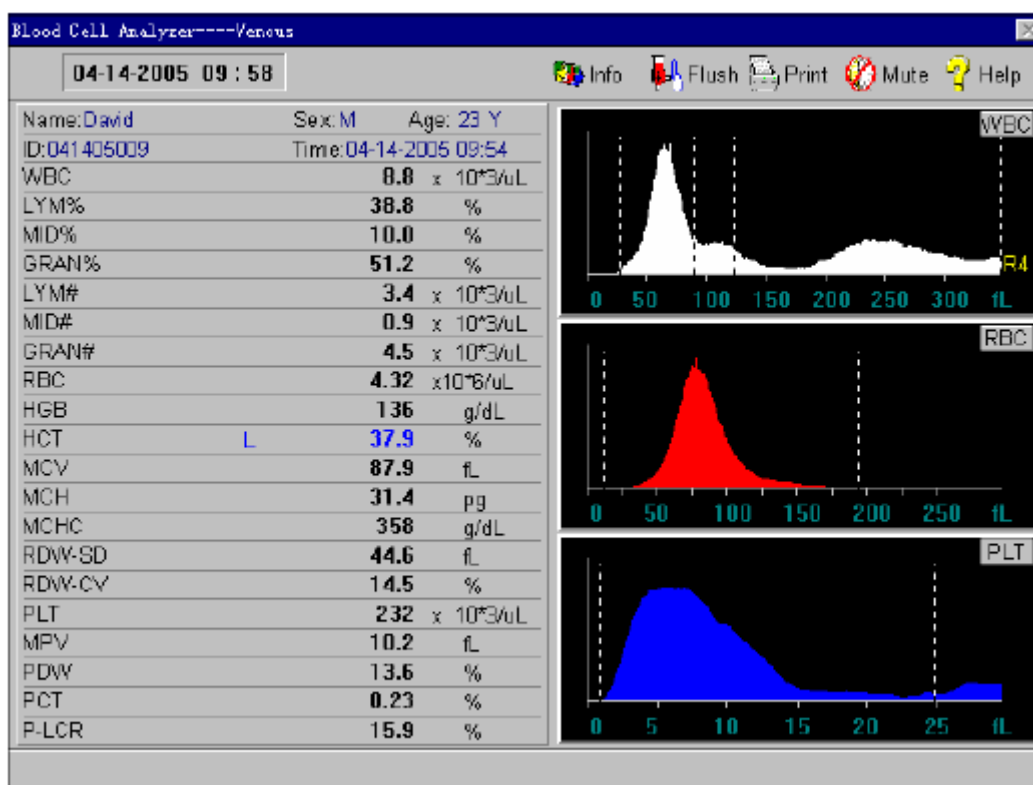

Figure 3-1

3.3 BACKGROUND TEST

Background test is recommended after the instrument startup normally every time. The operator can also perform background test in need. The operating procedures as follows:

- In the blood cell analyzer window, press "Info" button, and pops up the information edit window. Then click the item textbox, change the ID as 999, then press "OK", return to blood cell analyzer window.
- In venous or capillary mode, press the "START" key below the sample needle directly for background count. In prediluted mode, the sample needle aspirates some non-contaminated diluent from the sample cup for background count. The diluent pick-up method as follows (Analyzing the sample in prediluted mode, it is also necessary to dilute sample with the diluent which is prior picked-up in this method):

- 1) Press the right key of mouse in main operation area, pops up the menu. In menu operation area, select "Sample Mode"; Set up Prediluted as the sample mode.
 - 2) Press the right key of the mouse in main operation area, pops up the menu. In menu operation area, select "Diluent";
 - 3) Place a clean empty sample cup or tube under the sample needle, press "START" key to dispense the diluent into the sample cup. Press the "START" key once, the diluent is dispensed into the sample cup or tube once. (The quantity can be used for background count in the second prediluted mode).
Press "Exit" button, the instrument return to main operation area
- c) The permissive range of the background test results are shown as table 3-1.

Parameters	Data	Unit
WBC	≤ 0.3	$10^3/\mu\text{L}$
RBC	≤ 0.03	$10^6/\mu\text{L}$
HGB	≤ 0.2	g/dL
HCT	≤ 0.5	%
PLT	≤ 25	$10^3/\mu\text{L}$

Table 3-1

If the value of the background test exceeds the permissive range, repeat the upper testing procedures until the testing result is acceptable. If the test has been carried on above five times, the testing result still can not reach the standard required. Please refer to Chapter 10 "Troubleshooting" in this manual.

Notice:

Only five parameters WBC, RBC, HGB, HCT, PLT can be tested and displayed in background test.

Notice:

The serial number 999 is a special number for background test.

3.4 QUALITY CONTROL

It is necessary to perform quality control in installation for the first time or before sample analysis every day. Further information and procedures are given in Chapter 4 "Quality Control".

3.5 PREPARATION FOR SAMPLE COLLECTION

The sample can be collected either from capillary blood or from venous blood.

Warning:

Avoid directly contacting with the blood sample, control and calibration in any case.
Handle or dispose of these things according to acceptable laboratory or clinical standards.

3.5.1 Venous Blood Collection

It is possible to collect venous blood by using negative pressure tube or in common collecting method. Add some anticoagulant in advance to the container for venous blood collection. EDTA.K 2.2H 20 is commonly used as the anticoagulant, whose specified content is 1.5—2.2mg/ml blood.

3.5.2 Capillary Blood Collection

- **Parts for blood collection:**
 - Adult: Middle finger tip inner of the left hand, or ring finger tip inner of the left hand
 - Child (above six-month-old): Middle finger

Infant (under six-month-old): Outer side of the thumb or foot

- **Blood collection methods:**

1. Gently massage the blood collection part to make it congest naturally, wipe the partial skin with tampon containing 75% alcohol, then airing it.
2. Pinch the puncturing part, and puncture it with aseptic sample needle quickly. The puncturing depth is about 2-3mm.
3. Wipe off the first drop of blood, and then start collection.
4. Press the wound with tampon for a moment after finishing the collection.

Notice:

The capillary blood collection should follow the professional capillary blood collection standard. The general method is partial centesis. The typical collection is puncturing from the tip of the finger.

Caution:

If the blood flows not freely, press far away from the wound, not around the wound. Avoid the make the histiocyte mixing into the blood, resulting in incorrect analytical result.

3.5.3 Prepare Samples in Prediluted Mode

In the blood cell analyzer window, select "Sample Mode/Prediluted" in operation menu. Then select "Diluent". When the "Diluent" pops up, place a clean sample cup obliquely under the probe. Press "START" key. The instrument starts to add diluent quantificationally. When adding diluent, the indicator light glimmers quickly. Scrape the drops at the top of the sample needle into the sample cup when the indicator light glimmers slowly. Collect 20-L capillary sample in pipette. Wipe the blood attached on the outer layer of the pipette with clean tissues. Immediately mix up the sample in the diluent sample cup.

Caution:

When adding the diluent, the sample cup must be placed obliquely under the sample needle, which allows the diluent to run down the cup wall without forming air bubbles.

Notice:

If there is a need to prepare samples in quantities in prediluted mode, user can use the "Diluent" function to continuously prepare the diluent.

3.5.4 Prepare Samples in Capillary Mode

Collect 40-L capillary sample in pipettes. Immediately mix up the sample in anticoagulated warhead sample cup. You can also add the capillary blood to the anticoagulated warhead sample cup directly.

3.5.5 Sample Homogenization

The blood samples must be fully homogenized before use. The recommended method is: Shake up the tube up and down 3-5 minutes, blood mixer is recommended to make the sample be fully homogenized and ensure the accuracy of measurement.

Caution:

If the sample has been placed for a long time or mixed inadequately, it will easily cause measurement error and incorrect testing results.

Caution:

Avoid shaking up the pipette violently.

Caution:

The sample to be tested can only be stored at room temperature, and the test must be finished within 4 hours.

3.6 SAMPLE COUNT AND ANALYSIS

After finishing sample collection, perform count and analysis procedure as follows.

3.6.1 Input Sample Information

3.6.1.1 Input Manual Information

In the blood cell analyzer window, click "Info" button, pops up information edit window. Move the cursor to the required inputting item textbox. Input or select the data, and press "OK". The instrument will save the input information and returns to blood cell analyzer window. Pressing "Cancel" key, the instrument cancels the input information and returns to blood cell analyzer window.

Name: Maximum 12 letters.

Sex: Select male or female, and the default is blank.

Age: Choose from year, month and day. Maximum 3 numbers while choosing year; Maximum 2 numbers while choosing month and day.

Blood: Choose from A, B, O, AB, Rh +, Rh- . The default is blank.

Sample: The current sample mode.

Case Hist: Maximum 12 letters.

Bed No.: Maximum 12 letters.

ID.: The input range is: 001 --998. The instrument owns an intelligent number manager. The final number derives from the comprehensive information that the instrument adds the information of year, month and day in front of the input number according to the measured time. If user does not input the serial number, the instrument will accumulate the number from 001 everyday according to the measured time.

Department: Maximum 12 letters. You can also choose the recorded department information from the right optional textbox, or choose automatically by the instrument after inputting the code of the department in the left input textbox.

Send By: Maximum 12 letters. You can also choose the recorded doctor information from the right optional textbox, or choose automatically by the instrument after inputting the code of the doctor in the left input textbox.

Operator: Maximum 12 letters. You can also choose the recorded doctor information from the right optional textbox, or choose automatically by the instrument after inputting the code of the doctor in the left input textbox.

Physician: Maximum 12 letters. You can also choose the recorded doctor information from the right optional textbox, or choose automatically by the instrument after inputting the code of the doctor in the left input textbox.

Limits: Choose from general, men, woman, child, baby, define 1, define 2, and define 3 automatically. While choosing "Auto", the instrument gives the reference value automatically as shown in table 3-2.

Reference value	Age	Sex
General	Not entered	Blank ,Man, Woman
General	>13years old	Blank
Man	>13years old	Man
woman	>13years old	woman
child	1month ≤ Age ≤ 13years old	Blank ,Man, Woman
Baby	<1month	Blank ,Man, Woman

Table 3-2

Notice:

The number 999 is a special number for background test. Please don't input this number in blood sample test.

3.6.1.2 Input information with the bar code scanner

If the instrument is equipped with bar code scanner, make the scanner aim at the sample bar code.

It will read the sample information automatically. The scanner will make a prompt sound like " di" after completing successfully.

Notice:

If there is a need to input the sample test information in quantities, user can concentrate on inputting the sample test information in the review window after the current sample test finished.

3.6.2 Procedures of Sample Count and Analysis

- a) Place a sample cup under the sample needle, press "START" key, the indicator lamp on the front panel of the instrument begins to glimmer. The instrument starts to aspirate the liquid. Move the sample cup until the indicator lamp stops glimmering.
- b) The instrument starts to analyze the sample automatically. Please wait for the analytical result.
- c) After the analysis finished, the result will be displayed in the rear of the corresponding parameters on blood cell analyzer window of the instrument, with histograms WBC, RBC, and PLT. As shown in figure 3-1.

If "Auto" item is "ON" , the recorder or printer will output the test results automatically.

If there are clogs or bubbles during the count and analysis process, the information section would display "Clog" or "Bubble".

3.6.3 Parameter Alarm

"B": To indicate that bubble appears in the test.

"C": To indicate that clog appears in the test.

"L": To indicate the data has exceeded the setup lower alarm limit of the parameter.

"H": To indicate the data has exceeded the setup higher alarm limit of the parameter.

****: To indicate that the data is invalid.

Notice:

When PM alarm occurs on PLT histogram, the result of parameter PDW is ****.

Notice:

If the result of WBC is less than $0.5D10^9$ /L, the system will not perform leukocyte differential. The display for all parameters related to leukocyte differential is ****.

3.6.4 Histogram Alarm

"R1": To indicate the abnormality of the lymphocyte hump on the left. It may present platelets coagulate, large platelet nucleated red cell, insoluble red cell, abnormal lymphocyte, protein etc.

"R2": To indicate the abnormality between the lymphocyte and the mid-sized cell area. It may present atypical lymphocyte, abnormal lymphocyte, plasma cell, original cell or the increase of the number of the eosinophil or basophil.

"R3": To indicate the abnormality between the mid-sized cell and granulocyte. It may present immature granulocytes, abnormal sub-population in the sample, or the increase of the number of the eosinophil.

"R4": To indicate the abnormality on the right of granulocytes area. It shows the increase of the number of the granulocyte.

"RM": To indicate that more than two areas occurs abnormality. The upper reasons exist simultaneously.

"PM": To indicate the abnormality the blur demarcation between platelet and red blood cell area. Large platelet, platelet coagulation, small red blood cell, cell debris or fibrin may exit.

3.7 ANALYTICAL RESULTS MODIFICATION

If user thinks that the results of WBC, RBC, PLT differential can not meet the needs of the classification of special samples in clinical or laboratory, he can manually adjust the histograms.

Operate as follows:

- a) In the blood cell analyzer window, select "Histogram" in menu. The instrument accesses histogram adjustment window, as shown in figure 3-2. Press "Para" button to adjust the histogram.
- b) After selecting the histogram, press "Line" button, and select the sorting line you want to adjust.
- c) Press "Left" or "Right" button, you can remove the sorting line to the left or right, the data of the line will be displayed at the top right corner of the screen.
- d) Press "Exit" button when the adjustment finished. If this operation did not change any data, the system would return to the blood cell analyzer window directly. Or else pops up the "OK/Cancel" window. Press "OK" to save the adjustment result, while select "Cancel" to cancel the adjustment result.

Caution:

Unnecessary and incorrect manual adjustment will cause unreliable analytical result. Make sure the necessity of the operation.

Notice:

If the result of WBC is less than $0.5D10^9$ /L, the system will not perform leukocyte differential automatically.

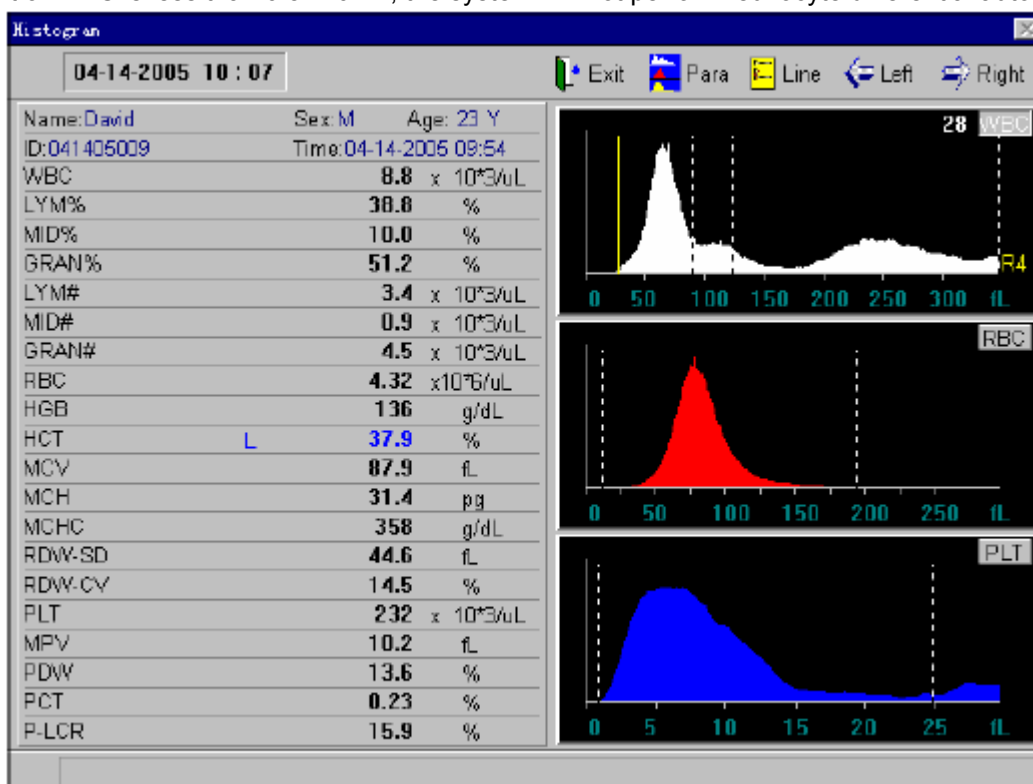

Figure 3-2

3.8 SHUTDOWN

Shutdown routine must be performed before turning off the power everyday.

During shutdown procedure, the instrument will perform daily maintenance and clean the tubing automatically.

The procedures are:

- In the blood cell analyzer window, press the right key of the mouse, pops up the menu. Select "Shutdown" in the menu, pops up shutdown window, as shown in Figure 3-3.
- If you do not want to shutdown the instrument for the moment, click "Cancel" to return to the blood cell analyzer window.
- Press "OK", the instrument will perform daily maintenance and clean the measuring tubing. When the shutdown procedure finished, the screen displays "Turn off the power now", turn off the power on the rear panel of the instrument.
- Turn off the printer power (if equipped), clean the workbench and dispose the waste.

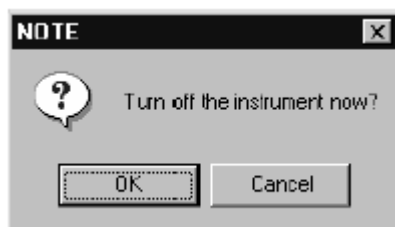

Figure 3-3

Notice:

Do not turn off the power of instrument directly while performing the shutdown procedure.

Chapter 4 QUALITY CONTROL

Quality Control means the precision, accuracy and repeatability of the system. Quality control provides reliable and effective methods for the possible system errors in detection and prevention.

The system errors may cause unreliable analytical result of the sample. To maintain the reliability of the analytical results, periodic quality control of the instrument is required.

The instrument provides 9QCfiles for user. It allows the operator run quality control to the 12 parameters at the same time.

At first select a QC file, enter the assay and limit of control data. The system allows the operator run quality control to the 12 parameters simultaneously or to some of the 12 parameters.

Caution :

Controls must be stored in appropriate conditions.

Caution:

Don not use controls deteriorated or out of its expiration date.

Caution:

Be sure to finish the quality control in a certain time every day.

4.1 EDIT QUALITY CONTROL FILES

The operating procedures as follows:

- a) In the blood cell analyzer window, press right key of the mouse, pops up the menu. Select "QC Edit" in the menu. The instrument enters quality control edit window, as shown in figure 4-1.

Para	Assay	Limit	Para	Assay	Limit
WBC	8.7	0.4	MCH		
RBC	4.31	0.15	MCHC		
HGB	134	4	LYM%		
PLT	228	30	GRAN%		
HCT			LYM#		
MCV	87.8	3.0	GRAN#		

Figure 4-1

- b) In quality control edit window, select the QC file you want.
- c) Input Lot No and Exp. Date of the control, the assay and limit of the quality control parameters.
- d) Press "Save" button to save the data of the current QC file.
- e) Press "Del" button to delete the data of the current QC file.
- f) Press "Exit" button to save the data of the current QC file and return to blood cell analyzer window.

Notice:

If the parameter is an invalid data, the system will take the assay and limit as no assignment. It needs to re-input. Or else the quality control will only act on other parameters.

Notice:

If the lot number or expiration date is invalid, the system will take them as no assignment. It needs to re-input. Or else the QC file can not run quality control program.

4.2 QUALITY CONTROL RUN

Input QC parameters and perform QC run of the specified file.

The operating procedures as follows:

- In the blood cell analyzer window, press right key of the mouse, pops up the menu. Select "QC Run" in the menu. The instrument enters quality control run window, as shown in figure 4-2.
- Prepare the controls and shake up the container until it well-mixed.

Para	Assay	Limit	001	002	003	004	005	006	007
Date			04/14/05	04/14/05	04/14/05	04/14/05	04/14/05	04/14/05	04/14/05
Time			10:36	10:39	10:40	10:42	10:45	10:46	10:48
WBC	8.7	0.4	8.5	8.9	8.8	9.0	8.7	8.6	9.0
RBC	4.31	0.15	4.24	4.29	4.43	4.36	4.22	4.21	4.34
HGB	134	4	134	135	137	137	135	133	137
PLT	228	30	242	233	236	254	228	244	233
HCT									
MCV	87.8	3.0	88.2	88.1	88.0	88.1	87.9	87.8	88.1
MCH									
MCHC									
LYM%									
GRAN%									
LYM#									
GRAN#									

Figure 4-2

- Place the controls under the sample needle. Press "START" key, the indicator lamp start to glitter on the front panel of the instrument, the instrument imbibes the controls, move the controls away until the indicator lamp stops glittering.
- When the measurement finished, the result will be displayed on the column of the current window. If alarm occurs in measurement, the current result may be incorrect. Press "Del" button to delete the result and test again after the problem is solved.
- Press "Exit" button, the instrument will return to blood cell analyzer window.

Notice:

Each QC file can store up to 31 QC data.

4.3 QUALITY CONTROL GRAPH

The graph provides a visual observation of the control data, allowing the operator to observe the possible deviations, trends or shifts of the instrument performance.

In the blood cell analyzer window, press the right key of the mouse, pops up the menu. Select "QC Graphs". The instrument enters quality control graph window, as shown in figure 4-3.

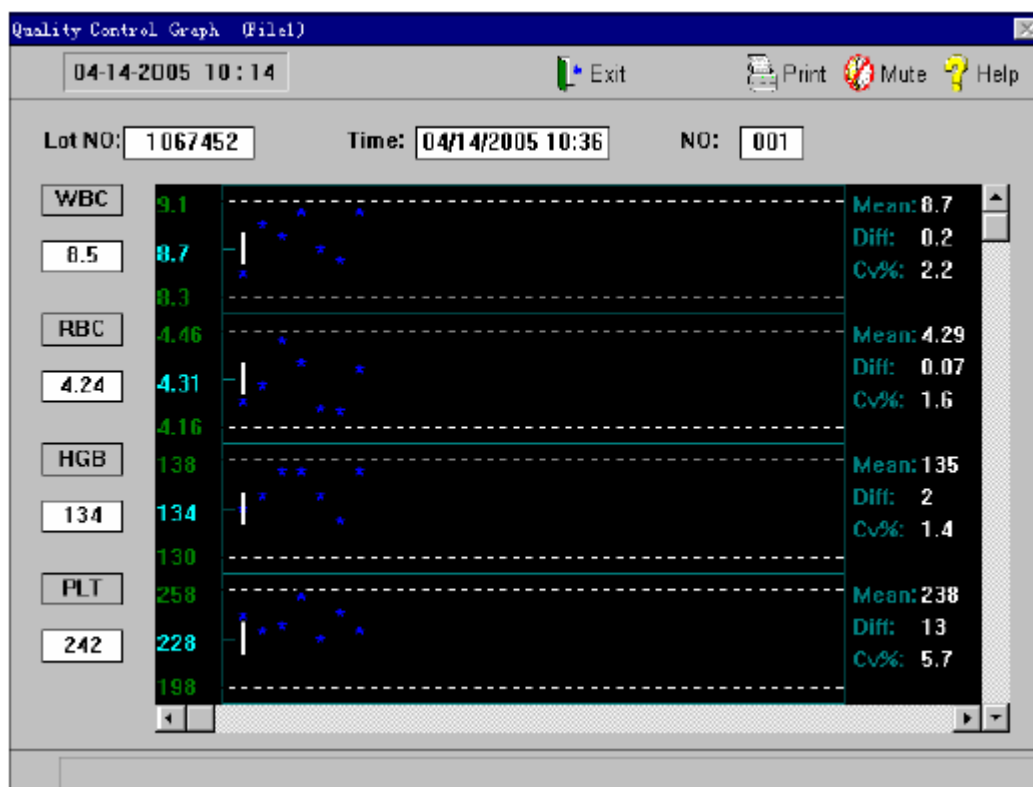

Figure 4-3

The screen can display 4 QC figures at the same time. The figure shows the lot number, time, number and distribution of the QC data. Click the scroll bar on the right of the screen. You can continuously select the QC graphs of different parameters.

The X-axis of the graph represents running times of the quality control. The broken line above the QC graph: assay+limit. The broken line below the QC graph: assay-limit.

The three parameters at the left side of the QC graphs from top to bottom:

- assay + limit
- assay
- assay - limit

The three parameters at the right side of the QC graphs from top to bottom:

- Mean:** average value
- Diff:** standard deviation
- CV:** coefficient of variation

The vertical line in the middle of the QC graphs indicates the current chosen number. Click the scroll bar on the left of the screen. You can continuously select the different number.

The chosen number is displayed in the data box below the corresponding parameter. The test time for the chosen number is displayed in the time box on the screen.

In the QC graphs window, the following marks represent:

The mark "*" between the broken line represents that the point is within control range. Otherwise it is out of control range.

The mark "." represents that the parameter value is outside the operating range, or error has occurred during the run. Blank represents that there is no quality control on running.

Press "Print" button, it will print the data of the parameters on the screen.

Press "Exit" button to return to the blood cell analyzer window.

4.4 QUALITY CONTROL TABLE

The instrument supplies tabulated format for QC review. In the blood cell analyzer window, press the right key of the mouse, select "QC Table". The instrument enters the quality control table window, as shown in figure 4-4.

Quality Control Table (File)

04-14-2005 10:15

Exit Print Mute Help

Lot NO: 1067452 Exp. Date: 06/15/2005

Para	std	dev	001	002	003	004	005	006	007
Date			04/14/05	04/14/05	04/14/05	04/14/05	04/14/05	04/14/05	04/14/05
Time			10:36	10:39	10:40	10:42	10:45	10:46	10:48
WBC	8.7	0.4	8.5	8.9	8.8	9.0	8.7	8.6	9.0
RBC	4.31	0.15	4.24	4.29	4.43	4.36	4.22	4.21	4.34
HGB	134	4	134	135	137	137	135	133	137
PLT	228	30	242	233	236	254	228	244	233
HCT									
MCV	87.8	3.0	88.2	88.1	88.0	88.1	87.9	87.8	88.1
MCH									
MCHC									
LYM%									
GRAN%									
LYM#									
GRAN#									

Figure 4-4

The screen can display the 12 QC parameters of 7 groups at the same time. Operate the scroll bar in to select different serial number. Press "Print" button, it will print the data of the parameters on the screen. Press "Exit" button to return to blood cell analyzer window.

Chapter 5 CALIBRATION

The instrument has been calibrated strictly at the factory. You may need to perform calibration procedures when you replace any component that involves the primary measurement characteristics, or when the shift occurs during controls. Calibration of the instrument is to provide the assurance that the instrument is providing results with accuracy as design.

The purpose of calibration is to ensure the accuracy of the measurement result meet the requirement of the design all the time.

To ensure the accuracy of the instrument and obtain reliable measurement results, it is necessary to calibrate the instrument in the following situations:

- a) Installation for the first time or re-setup in a new place.
- b) The instrument is maintained.
- c) The result of quality control is abnormal.
- d) Replace reagent.

To ensure the instrument's precision and obtain reliable measured results, the instrument should be calibrated in these situations:

Warning:

Calibrators should be stored and used properly according to the calibrator manual.

Warning:

Make sure the instrument is in a normal state before calibration.

Warning:

Avoid using the result of the measurement on medical test or clinical before the calibration is finished accurately.

Check the instrument and reagents carefully before calibration. Make sure the instrument in normal status, and make sure the required sample mode of the measurement.

5.1 MANUAL CALIBRATION

5.1.1 Background Test

Refer to Chapter 3 "Sample Analysis" / Section 3.3, Ensure that the background test meets the requirement and no malfunction occurs.

5.1.2 Assurance of Repeatability

To ensure the calibration accurate, it is necessary to evaluate the repeatability measurement of the instrument. Make sure the instrument is in normal status, then perform calibration program.

The procedures are as follows:

- a) In the blood cell analyzer window, Measure repeatedly with the calibration (no less than 3 times).
- b) Record the data of WBC, RBC, HGB, MCV, PLT. Calculate the CV value according to the following formula. Only the result is in the limit of table 5-1 can perform calibration.

$$CV = \frac{\sqrt{\frac{\sum_{i=1}^n (X_i - \bar{X})^2}{n-1}}}{\bar{X}} \times 100\%$$

\bar{X} -- average value of test result

X_i -- test result of the i times

n -- test times of the sample

Parameters	CV (%)
WBC	≤3.0
RBC	≤3.0
HGB	≤3.0
MCV	≤3.0
PLT	≤7.0

Table 5-1

5.1.3 Calculate Calibration Factors

Calculate the new calibration factors according to the following formula:

$$\text{new factor} = \frac{\text{current factor} \times \text{reference value}}{\text{average of test value}}$$

5.1.4 Modify the Calibration Coefficient

- In the blood cell analyzer window, press the right key of the mouse, pops up the menu. Select "Manual Calibration" in the menu, enters the calibration window, as shown in figure 5-1.
- Select the calibration data you need from the calibration data menu box.
- Press "Print" button. The instrument will print the current calibration result.
- Press "OK" button to save the current calibration result and return to the blood cell analyzer window.
- Press "Cancel" button. The instrument will cancel the current calibration result and return to blood cell analyzer window.

Notice:

The instrument allows the user to input the factors with the range between 70%~130%.

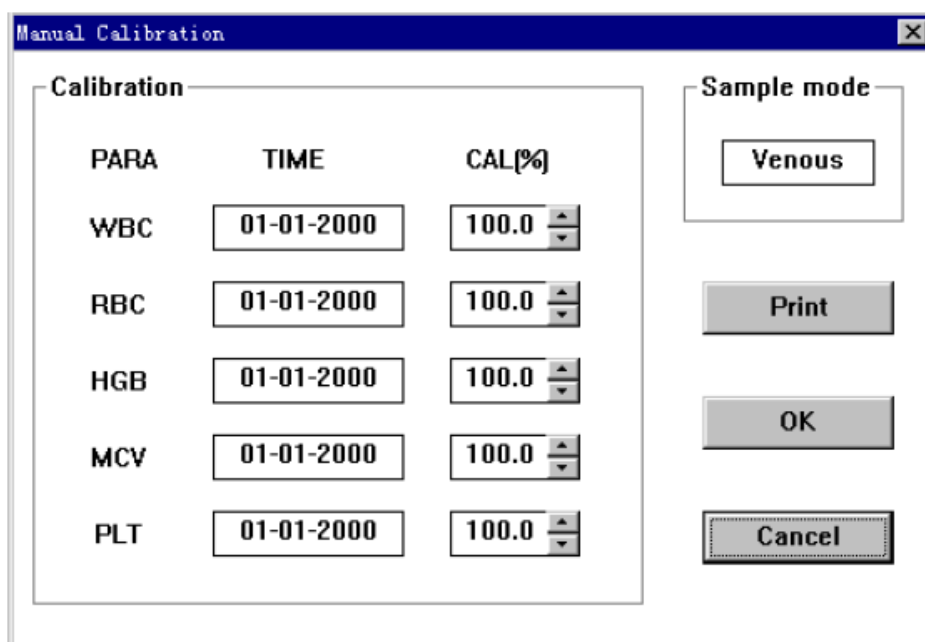

Figure 5-1

5.2 AUTO CALIBRATION

The procedures are as follows:

- In the blood cell analyzer window, press the right key of the mouse, select "Auto Calibration" in the menu. The instrument enters the auto calibration window, as shown in figure 5-2.
- Input the reference value of each calibration parameter.
- Prepare the calibrators and shake up the container until it well-mixed.
- Place the calibrators under the sample needle. Press "START" key, the indicator lamp start to glitter on the front panel of the instrument. The instrument imbibes the calibrators. Move the calibrators away until the indicator lamp stops glittering.
- When the measurement finished, the result will be displayed on the column of the current window. If alarm occurs in measurement, the current result may be incorrect.
- Press "Del" button to delete the result and test again after the problem is solved.
- Press "Exit" button, the instrument will return to the blood cell analyzer window.

Notice:

Calibration can be performed 5 times at the most.

Notice:

The calibration result will be displayed after testing 3 times.

Notice:

If the parameter is an invalid data, the system will not perform calibration. It needs to re-input valid data.

Notice:

The permissive range of the factors is between 70% and 130%. If the result exceeds the range, the system will not be able to save it. Find out the reason and perform calibration again.

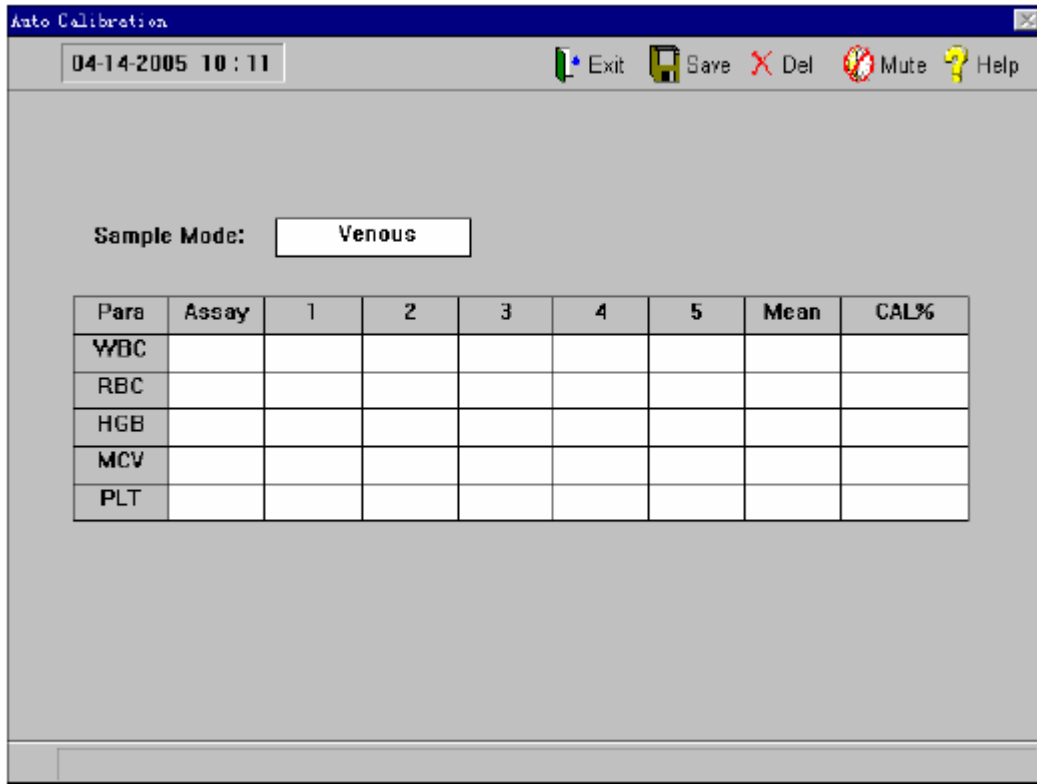

Figure 5-2

Chapter 6 SETTING

The instrument has accomplished all the settings at the factory. For customer's convenience, most of the system parameters can be setup by the operator so as to meet various requirements.

Notice:

The operations in this chapter will change the running state of the instrument. Please make sure the necessity of the changing before operating.

6.1 DATE & TIME

In the blood cell analyzer window, press the right key of the mouse, pops up the menu. Select "Function/Setting/ Date &Time". The instrument enters the time setting window. As shown in figure 6-1. Click the menu bar to adjust setting item.

Press "OK". The instrument will save the current parameters and return to the blood cell window.

Press "Cancel" button, the system will not save the current parameters and return to the blood cell window.

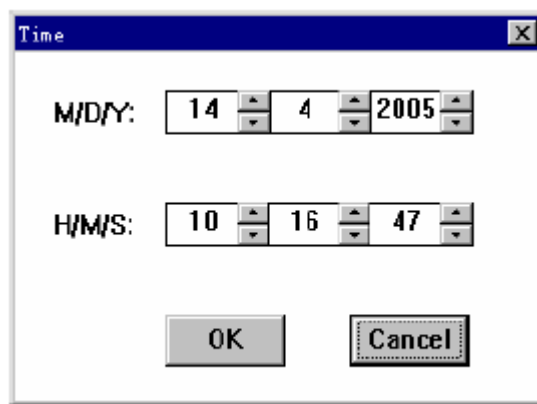

Figure 6-1

6.2 PRINTOUT

In the blood cell analyzer window, press the right key of the mouse, pops up the menu. Select "Function/Setting/ Printout". The instrument will enter the print window. As shown in figure 6-2.

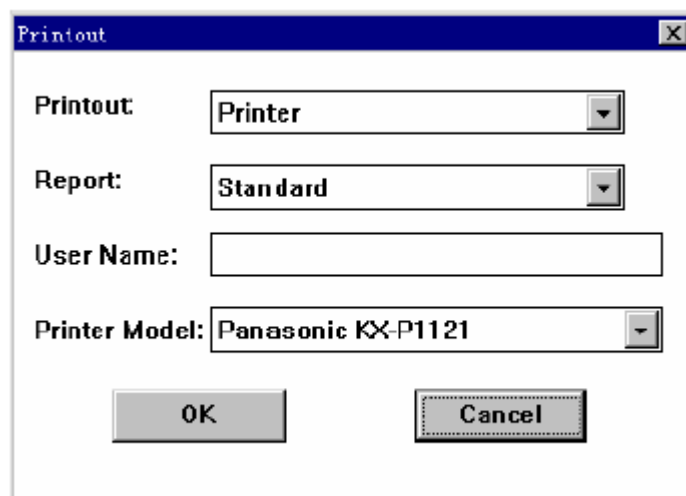

Figure 6-2

Click the menu box you want to adjust, pops up the optional window .Click the item you want to set.

Press "OK", the instrument will save the current parameters and return to the blood cell window.

Press "Cancel" button, the system will not save the current parameters and return to the blood cell window.

- **Print select**
 Select Recorder, the data will only be transported to the recorder.
 Select Printer, the data will only be transported to the printer.
 Select Net, the data will only be transported to net.
 Select Recorder and Net, the data will be transported to the recorder and net at the same time.
 Select Printer and Net, the data will be transported to the printer and net at the same time.
- **Output Formats of Printer**
 There are different formats when selecting different settings, described as follows:
 Printout set as "Recorder" or "Recorder, Net":
 Printout set as "Recorder" or "Recorder, Net":
 Set the printing format as default report format.
- **Print headline**
 Can easily printout the headline on the report.
- **Print type**
 User can choose the type of the printer.

Notice:

The selected printer type must be accord with as the used one, otherwise it will not be able to print normally.

6.3 CONFIG

In the blood cell analyzer window, press the right key of the mouse, pops up the menu. Select "Function/Setting/ Config", enter the print setting window. As shown in figure 6-2.

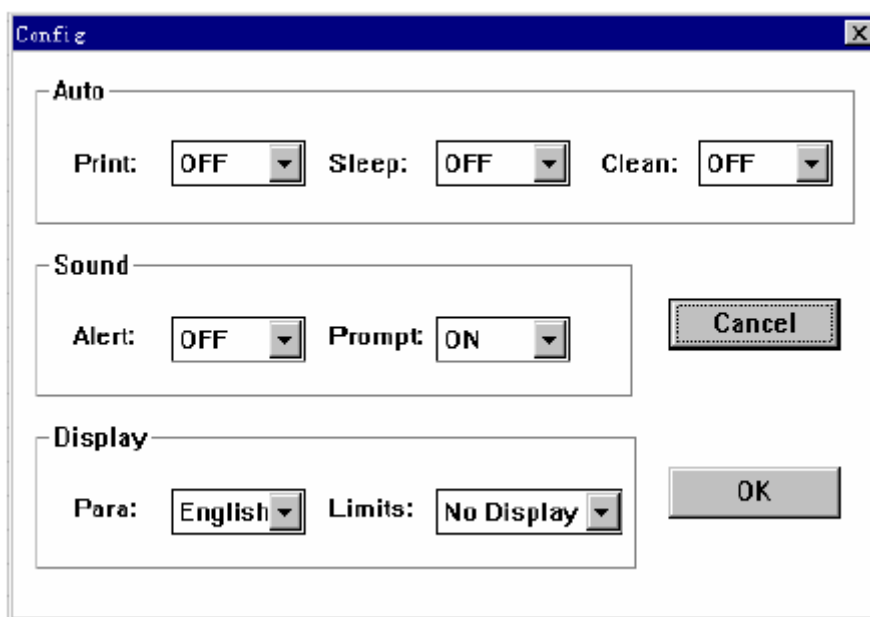

Figure 6-3

Click the menu box you want to adjust, pops up the optional window .Click the item you want to set.

Press "OK", the instrument will save the current parameters and return to the blood cell window.

Press "Cancel" button, the system will not save the current parameters and return to the blood cell window.

- **Auto**
 Set "Print" as "ON", the system will print the test report automatically after the sample test finished.
 Set "Sleep" as "OFF", the instrument will keep working status all along. Set "Sleep" as data. When the time, which the user does not perform any operation, exceeds the setting time, the instrument will access sleep state. During sleep time, the instrument will turn off part of the circuit power, and take the sample needle back. Sleep function can greatly save electrical energy and extend the life of the instrument. Press the left key of the mouse or any key on the keyboard, sleep will be canceled.

Set "Clean" as "OFF", the instrument will not perform auto-cleaning. Set "Clean" as data. When the running time of the instrument exceeds the setting time, the instrument will perform "Clean" procedure once. It can ensure the measured tubing of the instrument clean and prevent the possible measurement malfunctions and maintain the instrument.

- **Sound**

Set "Alert" as "OFF". When the instrument appears alarm, it will not make alarm sound, but display the alarm information in the Information Section.

Set "Alert" as "ON". When the instrument appears alarm, it will make alarm sound and display the alarm information in the Information Section.

Set "Prompt" as "OFF". When the sample measurement finished, the instrument makes no sound.

Set "Prompt" as "ON". When the sample measurement finished, the instrument will make a prompt sound like "di".

- **Display**

Set "Para" as "English". In parameter area of the blood cell analyzer, the parameters will be displayed in abbreviations.

Set "Limits" as "No Display". In parameter area of the blood cell analyzer, the parameters will not display reference value of the current sample.

Set "Limits" as "Low To High". In parameter area of the blood cell analyzer, the reference values will be displayed from low to high.

Set "Limits" as "High To Low". In parameter area of the blood cell analyzer, the reference values will be displayed from high to low.

6.4 LIMITS

In the blood cell analyzer window, press the right key of the mouse, pops up the menu. Select "Function/Setting/ Limits", enter the limits setting window. As shown in figure 6-4.

The 8 Group reference values are displayed at the left side of the screen. The dot in front of the reference value represents that this is the current selected reference group. The limits of the reference value are displayed on in the limits boxes on the screen.

Click the dot in front of the group to select the group required for setting.

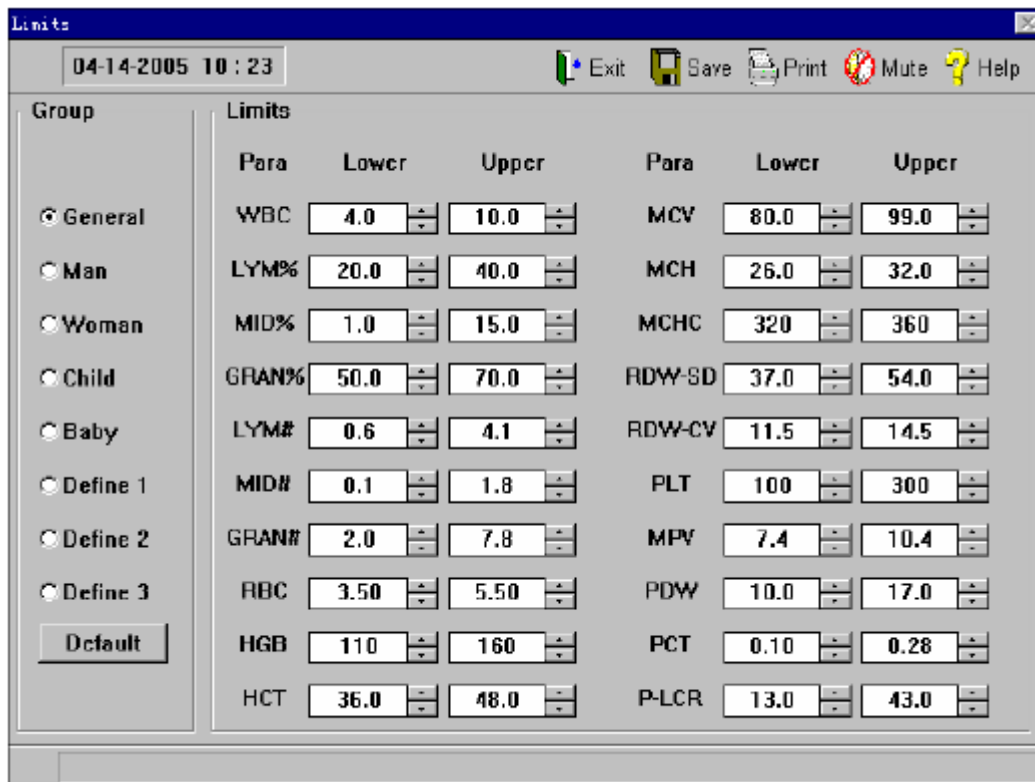

Figure 6-4

Click "Default" button, the instrument will select the default reference values to replace the current reference values.

Click the adjustable bar of the limits box to adjust the upper and lower limit of the reference value.

Function of menu and shortcut keys:

Save: Save the reference values of the current group.

Print: Print the reference values of the current group.

Mute: To clear the sound of the occurred malfunction alarms.

Help: Enter help window, you can obtain help on line.

Exit: Quit from current window, and return to blood cell analyzer window.

Notice:

The default reference value may not suitable for the local conditions. User can modify it according to the local specific circumstances.

Caution:

The changing of the reference value will cause variation of abnormal prompt on hematology target. Please make sure the necessity of the variation.

6.5 DEPARTMENT

The department information can help user setup perfect sorting information in advance, and quicken the input speed and management of the sample information. Especially the abbreviation greatly improves the communication and standardization construction of laboratory digital information

In the blood cell analyzer window, press the right key of the mouse, pops up the menu. Select "Function/Setting/ Department", the instrument enters department setting window. As shown in figure 6-5.

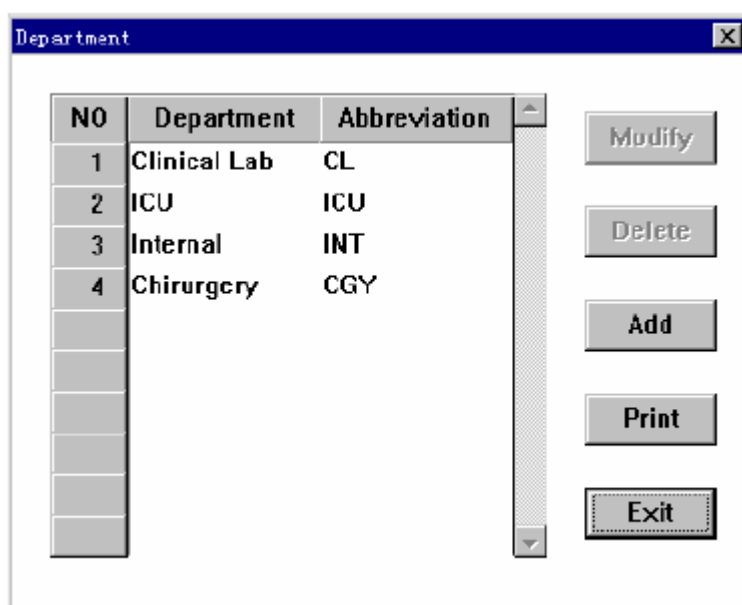

Figure 6-5

Click the scroll bar at the right side of the window, the instrument can record the serial number continuously. Click "Exit" button, the system exit from the current window and return to blood cell analyzer window.

6.5.1 Add Record Information

Click "Add Record" button, enters add record window, as shown in figure 6-6.

Input the information of department and abbreviation.

Click "Cancel" button, the current input information will be canceled, and the system returns to department setting window.

Click "OK" button to save the current input information. The system returns to department setting window.

Notice:

The coding method of the abbreviation should be easy to memory. In most circumstances, the abbreviation of the department name is recommended.

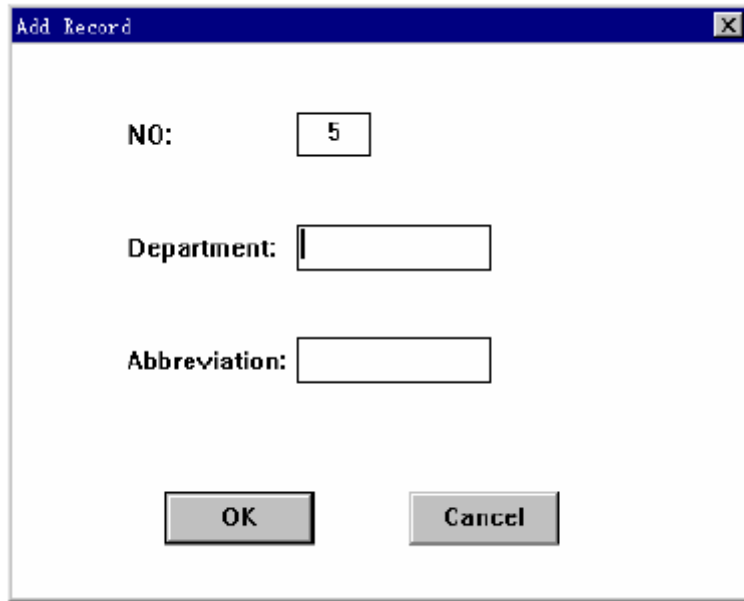

The screenshot shows a dialog box titled "Add Record". It contains three input fields: "NO:" with the value "5", "Department:" which is empty, and "Abbreviation:" which is empty. At the bottom, there are two buttons: "OK" and "Cancel".

Figure 6-6

6.5.2 Modify Department Information

Click the number you want to modify. Then press "Modify" button, the system enters modify window, as shown in figure 6-7.

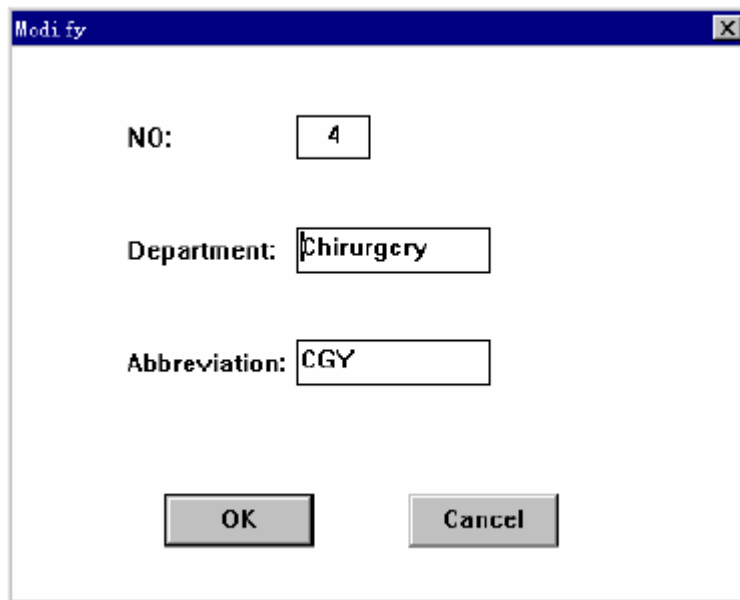

The screenshot shows a dialog box titled "Modify". It contains three input fields: "NO:" with the value "4", "Department:" with the value "Chirurgery", and "Abbreviation:" with the value "CGY". At the bottom, there are two buttons: "OK" and "Cancel".

Figure 6-7

Modify the information you want to change.

Click "Cancel" button, the current input information will be canceled, and the system returns to department setting window.

Click "OK" button to save the current input information, and the system returns to the department set up windows.

6.5.3 Delete department information

Click the serial number you want to modify, then click "Delete" button, the selected department information will be deleted.

6.5.4 Print Department Information

Click "Print" button. The instrument will print all the department information saved.

6.6 OPERATOR INFORMATION

The operator information can help user setup perfect sorting information in advance, and quicken the input speed and management of the sample information. Especially the name greatly improves the communication and standardization construction of laboratory digital information.

In the blood cell analyzer window, press the right key of the mouse, pops up the menu. Select "Function/Setting/ operator", the instrument enters the operator setting window. As shown in figure 6-8.

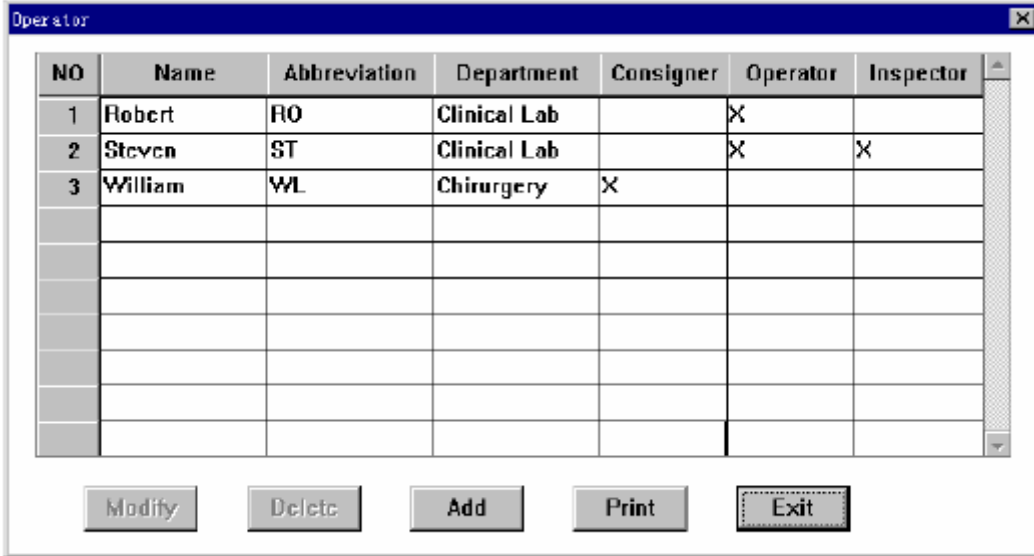

NO	Name	Abbreviation	Department	Consigner	Operator	Inspector
1	Robert	RO	Clinical Lab		X	
2	Steven	ST	Clinical Lab		X	X
3	William	WL	Chirurgery	X		

Modify Delete Add Print Exit

Figure 6-8

Click the scroll bar at the right side of the window to display continuously the records of different numbers. Click "Exit" button, the system will exit the current window and return to blood cell analyzer window.

6.6.1 Add Operator Information

Click "Add Record" button. The instrument enters add record window, as shown in figure 6-9.

The screenshot shows a dialog box titled "All Record". It has the following fields and options:

- NO:** Input field containing the number "4".
- Name:** Empty input field.
- Abbreviaton:** Empty input field.
- Department:** Two input boxes; the left one is empty, and the right one is a dropdown menu.
- Status:** A group box containing three checkboxes:
 - Consigner
 - Operator
 - Inspector
- Buttons:** "OK" and "Cancel" buttons at the bottom center.

Figure 6-9

Input the information of name and abbreviation.

Input abbreviation information at the left input box of department, the system will select department automatically. You can also select the department directly from the right input box of the department.

"Status" represents the status of the doctor, including: consigner, operator and inspector. Click the box in the left directly, blank means no choice, black fork means selected. Selecting more than one item is allowed.

Notice:

The coding method of the abbreviation should be easy to memory. In most circumstances, the abbreviation of the department name is recommended.

6.6.2 Modify Operator Information

Click the serial number you want to change, then click "Modify" button, the system would enter to record modify windows, as figure 6-10 shows.

The screenshot shows a dialog box titled "Modify". It has the following fields and options:

- NO:** Input field containing the number "2".
- Name:** Input field containing the text "Steven".
- Abbreviaton:** Input field containing the text "ST".
- Department:** Two input boxes; the left one is empty, and the right one is a dropdown menu showing "Clinical Lab".
- Status:** A group box containing three checkboxes:
 - Consigner
 - Operator
 - Inspector
- Buttons:** "OK" and "Cancel" buttons at the bottom center.

Figure 6-10

Modify the information of department and abbreviation as you want.

Click "Cancel" button, the current input information will be canceled, and the system returns to department

setting window.

Click "OK" button to save the current input information, and returns the system to department setting window.

6.6.3 Delete operator Information

Click the serial number you want to modify, then click "Delete" button, the selected department information will be deleted.

6.6.4 Print Operator Information

Click "Print" button. The instrument will print all the operators information saved.

Chapter 7 REVIEW

The instrument can automatically store the results after each sample analysis. The operator can review, search, modify, print, and delete the data.

7.1 SAMPLE REVIEW

In the blood cell analyzer window, press the right key of the mouse, pops up the menu. Select "Function/Review" in the menu. As shown in figure 7-1.

NO	041405009	041405008	041405007	041405006	041405005	041405004	041405003	041405002
Date	04/14/05	04/14/05	04/14/05	04/14/05	04/14/05	04/14/05	04/14/05	04/14/05
Time	09:54	09:51	09:49	09:48	09:46	09:45	09:43	09:42
WBC	8.8	8.6	8.6	8.6	8.6	8.7	8.7	8.9
LYM%	38.8	38.7	39.3	38.8	38.9	38.4	37.9	39.0
MID%	10.0	10.6	9.8	9.4	9.9	10.3	10.5	9.2
GRAN%	51.2	50.7	50.9	51.8	51.2	51.3	51.6	51.8
LYM#	3.4	3.3	3.4	3.3	3.3	3.3	3.3	3.5
MID#	0.9	0.9	0.8	0.8	0.9	0.9	0.9	0.8
GRAN#	4.5	4.4	4.4	4.5	4.4	4.5	4.5	4.6
RBC	4.32	4.27	4.33	4.28	4.36	4.23	4.34	4.36
HGB	136	134	134	134	133	134	136	134
HCT	37.9 L	37.4	38.1	37.4	38.0	37.2	38.1	38.2
MCV	87.9	87.8	88.0	87.4	87.2	88.1	88.0	87.8
MCH	31.4	31.3	30.9	31.3	30.5	31.6	31.3	30.7
MCHC	358	358	351	358	350	360	356	350
RDW-SD	44.6	42.7	40.9	42.7	42.7	40.9	40.9	42.7
RDW-CV	14.5	13.9	13.2	13.9	14.0	13.2	13.2	13.9
PLT	232	223	223	223	238	233	229	221
MPV	10.2	10.3	10.0	9.9	10.4	10.6 H	10.5 H	10.6 H
PDW	13.6	13.3	13.3	13.8	13.3	13.8	14.1	14.1
PCT	0.23	0.22	0.22	0.22	0.24	0.24	0.24	0.23
P-LCR	15.9	16.1	15.1	15.1	17.6	18.1	18.3	18.2

Figure 7-1

The data can be reviewed and printed in table.

8 sample parameters are displayed in each review screen in the order of time sequence.

The button of scroll bars at the bottom of the screen shows the current position.

The meaning of the characters as follows:

"H" is displayed following the parameter indicating that the results exceed the high limit of the system.

"L" is displayed following the parameter indicating that the results exceed the low limit of the system.

"C" is displayed following the parameter indicating that clogs occur during the test.

"B" is displayed following the parameter indicating that bubbles occur during the test.

- **Review the sample data**

Click the left button of scroll bar at the bottom of the screen to review the rear data.

Click the right button of scroll bar at the bottom of the screen to review the front data.

Click the left side of the button at the bottom of the screen to review the data of the next page.

Click the right side of the button at the bottom of the screen to review the data of the front page.

Hold the button at the bottom of the screen, and draw the mouse to review the sample data quickly.

- **Delete the selected data**

The procedures as follows:

a) Click "NO" button at the top of the screen, the data will be selected. Click again, the selection will be canceled.

b) Select "Delete" in the menu, pops up a dialog box, let user choose to delete the data or not. Press

"OK" button, the data will be deleted. Press "Cancel" button, the operation will be cancelled.

- **Delete all data**

The procedures as follows:

a) Press the right key of the mouse, pops up the menu. Then click "Select All" button, the data will be selected. Click again, the selection will be canceled.

b) Press the right key of the mouse, and click "Delete" button, pops up a dialog box, et user choose to delete the data or not. Press "OK" button, the data will be deleted. Press "Cancel" button, the operation will be cancelled.

- **Print the current sample data in table**

The procedures as follows:

a) Click "NO" button at the top of the screen, the data will be selected. Click again, the selection will be canceled.

b) Click "Print" shortcut key, the selected data would be printed in table..

- **Search sample data**

Print the selected data as the following procedures:

a) Click right key of the mouse, pops up the menu. Select "Search" in the menu, pops up the search window, as shown in figure 7-2.

b) Click the box on the left of the item in need to search. "X" in the box means you has chosen the item, input the key word you want to search.

c) Repeat the b) procedure until the current inputting item finished. Click "Cancel" button to cancel the searching. Click "OK" button, start to search the data. When the searching finished, the proper sample data will be displayed on the screen.

The screenshot shows a 'Search' dialog box with the following fields and options:

- Name: []
- Date: Start [01] [14] [2005] End [04] [14] [2005]
- Sex: [M]
- Age: [] []
- Sample mode: [Venous]
- Blood: []
- Department: [] []
- Case Hist: []
- Consigner: [] []
- Bcd NO: []
- Operator: [] []
- ID: []
- Inspector: [] []

Buttons: [OK] [Cancel]

Figure 7-2

The functions of the menu and shortcut keys as follows:

All select: select or recover all the sample data.

Detail: Enter the detail review window.

Search: Search the required sample data in any condition.

Delete: Delete the selected data.

Print: Print the current data in table.

Mute: Get rid of the malfunction alarm.

Help: Enter help window to obtain the help on line.

Exit: Exit from the current window and return to blood cell analyzer window.

7.2 DETAIL REVIEW

In detail review window, select "Detail" by menu or shortcut key. The instrument will access the detail review window, as shown in figure 7-3.

This window review, modify, and print the sample data in graphs.

- **Review**
Click "Next" button to review the next data.
Click "Previous" key to review the previous data.
- **Modify Sample Information**
Click "Info" shortcut key, pops up "Information" window. The operation of this window refers to Chapter 3"Sample Analysis"/ Section3.6.1.
- **Modify Sample Data**
Click the right key of the mouse, pops up the menu. Select "Histogram" in the menu.
The operation procedures as follows:
a) Click "Para" shortcut key, you can select WBC, RBC, PLT in turn.
b) Click "Line" shortcut key, you can select the sorting lines in the histogram.
c) Click "Right" or "Left" shortcut key, you can move the sorting line to right or left.
The data calculated according to the new sorting line would be displayed in the data area at the left side of the screen.
d) Click "Exit" shortcut key. If user has modified the sample data, there will a dialog box pops up. User can select save the modification result or not. Click "OK" button, the result will be saved, Click "Cancel" button, the result would not be saved and the system exit from histogram modification status.

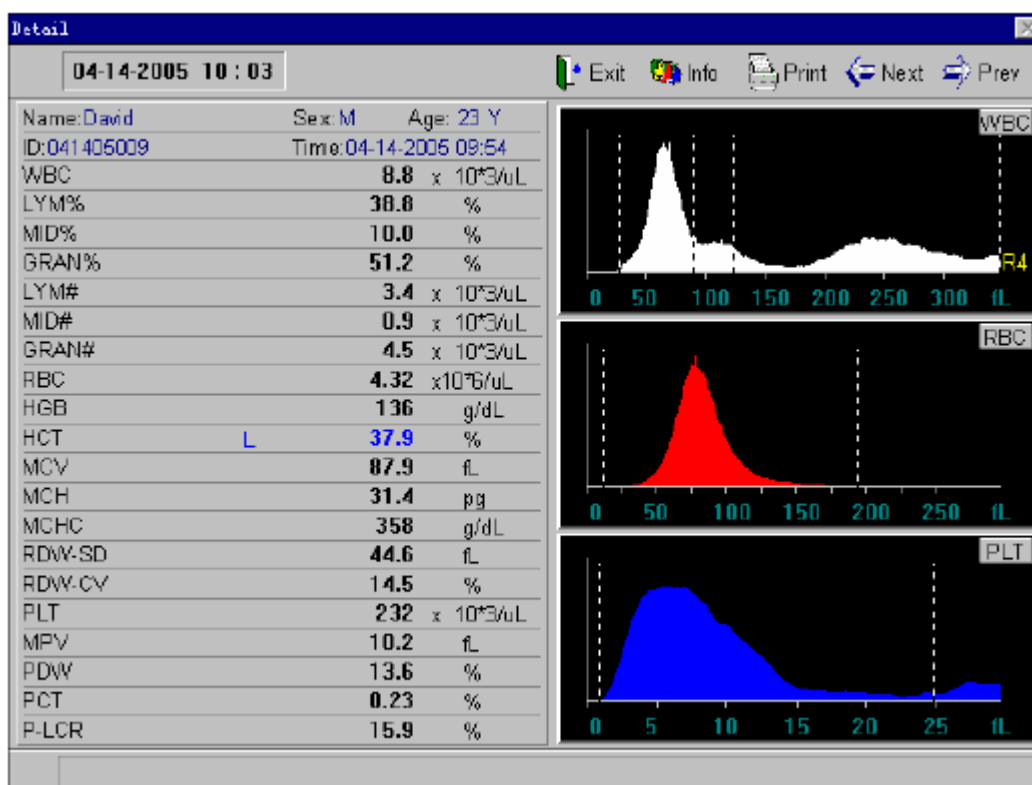

Figure 7-3

The functions of the menu and shortcut keys as follows:

Previous: Review the previous data.

Next: Review the next data.

Information: Input and modify the sample data.

Print: Print the current sample data.

Mute: Get rid of the malfunction alarm.

Help: Enter help window to obtain the help on line.

Exit: Exit from the current window and return to blood cell analyzer window.

Chapter 8 SERVICE

This chapter gives the description of various service functions provided by the instrument. These functions will bring user convenient and pleasure.

In the blood cell analyzer window, press the right key of the mouse, pops up the menu. Select "Function/Service".

8.1 FLUSH

This function is used for solving general probe clogs.

The instrument makes a fixed pressure and voltage act on the probe to get rid of the clogs.

8.2 ENHANCED FLUSH

This function is use to solve indolent probe clogs.

Probe cleaner would be injected into WBC and RBC count pool. Get rid of the indolent probe clog by soaking it in the probe cleaner. Before performing the function, user should prepare the probe cleanser well.

8.3 CLEANING

This function is used for the routine cleaning of the probe, sample needle, metering tube measurement tubing.

8.4 ENHANCED RINSE

This function is used for the enhanced cleaning of the probe, sample needle, metering tube, measurement tubing.

8.5 DRAIN CHAMBERS

This function is used for user to observe the count pool. The instrument will empty the liquid in the count pool.

8.6 PARK

Manufacturer suggests you do not use this function .If the instrument is not going to be used in 2 week or longer, use this function to clean and empty the instrument. It is convenient for user to store the instrument. Prepare distilled water before performing the function. .

8.7 PRIME DILUENT

Prime diluent to relative tubing.

8.8 PRIME LYSE

Prime lyse to relative tubing.

8.9 PRIME RINSE

Prime rinse to relative tubing.

8.10 MAINTENANCE

User can finish the weekly maintenance according to the prompt information on the screen.

Prepare rinse and probe cleaner before performing the function.

8.11 MECHANIC

The password is 6800.

Enter mechanic window. User can complete the detection of the valve, motor, circuit and interface.

It is helpful to the insurance of the malfunction.

Valve:

"ON" represents the valve is on.

"OFF" represents the valve is off.

Motor:

"OK" represents that the motor is in normal status.

"FAIL" represents the motor is failure.

Circuit:

"OK" represents the circuit is in normal status.

"FAIL" represents the circuit is failure.

"OFF" represents no negative pressure.

"ON" represents there is negative pressure.

"LOW" represents the temperature is below 18k.

Function of the menu and shortcut keys:

Mute: To get rid of the alarm sound.

Help: Enter help window to obtain help on line.

Exit: Exit from the current window and return to blood cell analyzer window.

8.12 Special

The instrument enters special maintenance window. User can adjust the running control data.

This function should be performed in guidance of the engineers of authorized by BGT.

Chapter 9 MAINTENANCE

As other precision instrument, only careful daily service and periodic maintenance can the instrument have a good working status, and can we get the reliable measurement results and have few malfunctions. This chapter introduces some preventive methods for service and maintenance.

If you want to know more relative information, please contact the customer service department of BGT.

According to the requirements for maintenance of the instrument during the using procedures, we divide the preventive service and maintenance into the following types: daily, weekly, monthly, yearly and maintenance according to actual need.

Warning:

It is important for the hospital or organization that employs this instrument to carry out a reasonable maintenance schedule. Neglect of this may result in machine breakdown.

9.1 ROUTINE MAINTENANCE

9.1.1 Clean the Appearance

Wipe the appearance of the instrument with neutral detergent or distilled water.

Caution:

Avoid using corrosive acids, alkali, and volatile organic solvent such as: acetone, aether, chloroforms to wipe the appearance of instrument. Only neutral detergent can be used.

Caution:

Avoid wiping the inner of the instrument.

9.1.2 Replace Fuse

The fuse is installed in the fuse-box on the side of power switch. Open the box to replace the fuse expediently. Appointed specification fuse: AC 250V 2A

Warning:

Only appointed specification fuse can be used.

9.2 DAILY MAINTENANCE

It can be divided into two types: run and shutdown.

- **Run**
The instrument has installed daily maintenance procedure.
On running, it can execute auto cleaning procedure according to the quantity of the sample to keep the instrument in good working status. Set the auto cleaning procedure according to the section 6.3. The general setting principles are:
Working time > 8 hours, auto-cleaning time=8 hours;
4 hours<Working time<8 hours, auto-cleaning time=4 hours;
Working time< 4 hours, auto-cleaning time=2 hours;
The auto-cleaning time will decrease 1 hour year by year.
- **Shutdown**
When the instrument shutdown, it will run daily shutdown auto cleaning procedure. You only need to clean the workbench and wipe the appearance of instrument when the power-off.

9.3 WEEKLY MAINTENANCE

This instrument has installed weekly maintenance procedure. Act as follows:

- a) Prepare E-Z cleanser and probe cleanser.
- b) In the main operation window, press the right key of the mouse, pops up the menu. In the menu area, select "Service/Maintenance". Operate as the screen shows.
- c) Turn off the power supply.

- d) Wipe the appearance of instrument as section 9.1.1.

9.4 MONTHLY MAINTENANCE

It is necessary to clean the dust of the instrument monthly.

Operate as follows:

- a) Turn off the power supply, and pull out the power line.
- b) Hold up the air filter cover with slotted screwdriver.
Take off the cover and the net. Clean them with neutral detergent brush and put them in the shade.
- c) Airing naturally .Brush away the dust clinging on the air filter grid at the rear panel of instrument.
- d) Put the air filter grid on the air filter net carefully. Planish them.

Notice:

Only can use the neutral detergent cleaning the air filter. Avoid airing it with heat.

9.5 YEARLY MAINTENANCE

It's necessary to perform preventive maintenance once every year. Because of the highly-requirements for yearly maintenance, the maintenance should be performed by the authorized engineer of BGT. Please contact the customer service department of BGT before yearly maintenance.

9.6 MAINTENANCE BEFORE TRANSPORT OR FOR THE INSTRUMENT THAT WILL NOT BE USED FOR A LONG TIME

If the instrument is not going to be used in 2 weeks or longer, or need to pack and transport, performing the following procedures:

- a) In the main operation window, press the right key of the mouse, choose "Service/Park" in the menu.
- b) Operate as screen shows.
- c) Rotate the bottle covers of rest reagents and store them as the reagent operation introduction.
User should perform efficient action to prevent the material from deteriorating, mis-eating and misusing.
- d) Plug the stopples which were pulled out at the first installation into the corresponding tube connector.
- e) Pull out diluent connection tube, rinse connection tube, lyse connection tube and waste connection tube and clean them with distilled water. Dry them in shady place, then packing them into plastics.
- f) Pull out the power wire, packing it in plastics after cleaning with neutral detergent.
- g) Put the instrument and parts packed in plastics into packing cases.

CHAPTER 10 TROUBLESHOOTING

This chapter contains information that is helpful in identifying and resolving instrument problems that may occur in the operation of the analyzer. If the problems can not be corrected with the aid of this chapter, the user should contact the Customer Service Department of BGT.

10.1 ABNORMAL STARTUP

Methods and procedures:

- a) Check if the power is on.
- b) Check if the power socket is loose.
- c) Check if the fuse is broken. If broken, replace it as section 9.1.2.

10.2 WASTE FULL

Methods and procedures:

Dispose of the waste in waste container.

10.3 DILUENT EMPTY

Methods and procedures:

- a) Replace diluent.
- b) In the blood cell analyzer window, press the right key of the mouse, pops up the menu. Select "Function/Service/Prime Diluent" in the menu.

10.4 LYSE EMPTY

Methods and procedures:

- a) Replace lyse.
- b) In the blood cell analyzer window, press the right key of the mouse, pops up the menu. Select "Function/Service/Prime Lyse" in the menu.

10.5 RINSE EMPTY

Methods and procedures:

- a) Replace Rinse.
- b) In the blood cell analyzer window, press the right key of the mouse, pops up the menu. Select "Function/Service/Prime Rinse" in the menu.

10.6 WBC CLOG OR RBC CLOG

If the count time exceeds high limit of the setting during measurement, there will "Clog" alarm occurs.

Methods and procedures:

- a) In the blood cell analyzer window, press "Flush" shortcut key.
- b) If the upper method could not solve the problem, perform as the following procedures.
- c) In the blood cell analyzer window, press the right key of the mouse, pops up the menu. Select "Function/ Service/ Enhanced Flush" in the menu. Follow the screen prompt information to finish it.

10.7 WBC BUBBLES OR RBC BUBBLES

If the count time exceeds low limit of the setting during measurement, there will be "Bubble" alarm occurs.

Methods and procedures:

In the blood cell analyzer window, press the right key of the mouse, pops up the menu. Select "Function/ Service/ Enhanced Flush" in the menu.

10.8 HGB ERROR

Methods and procedures:

- a) In the blood cell analyzer windows, press the right key of the mouse, pops up the menu. Select "Function/Service/ Cleaning".
- b) If the upper method could not solve the problem, perform as the following procedures.
- c) In the blood cell analyzer window, press the right key of the mouse, pops up the menu. Select "Function/ Service/ Enhanced Cleaning" in the menu.

10.9 HGB BUBBLES

Methods and procedures:

- a) In the blood cell analyzer windows, press the right key of the mouse, pops up the menu. Select "Function/Service/ Cleaning".
- b) If the upper method could not solve the problem, perform as the following procedures.
- c) In the blood cell analyzer window, press the right key of the mouse, pops up the menu. Select "Function/ Service/ Enhanced Cleaning" in the menu.

10.10 RECORDER OUT OF PAPER

Methods and procedures:

- a) Gently press the recorder door to open it.
- b) Insert the new paper into the paper entry, and make the printing side towards the thermal head.
- c) When the paper juts out from the other side, pull it out and keep it straight.
- d) Pull the paper out of the paper exit.
- e) Close the door of the recorder.

10.11 RECORDER TOO HOT

Possible reasons:

The thermal head of the recorder is too hot.

Methods and procedures:

Suspend using the recorder for 5 minutes.

10.12 THE RESULT OF BACKGROUND TEST TOO HIGH

Methods and procedures:

- a) In the blood cell analyzer window, press the right key of the mouse, pops up the menu. Select "Function/Service/ Cleaning".
- b) If the upper method could not solve the problem, repeat the procedure 3 times. If the problem still can not be solved, perform as the following procedures.
- c) In the blood cell analyzer window, press the right key of the mouse, pops up the menu. Select "Function/Service/ Enhanced Cleaning".
If the upper method could not solve the problem, repeat the procedure 3 times. If the problem still can not be solved, perform the upper procedure after replacing all the reagents.

CHAPTER 11 HELP

The instrument provides on-line help during operation. It is helpful for user to solve common problems and indicate the next operation.

Besides, the instrument provides help for user to read and search the information in window.

In the blood cell analyzer window, press the right key of the mouse, pops up the menu. Select "Help" in the menu, the help windows will pop up. As shown in figure 11-1.

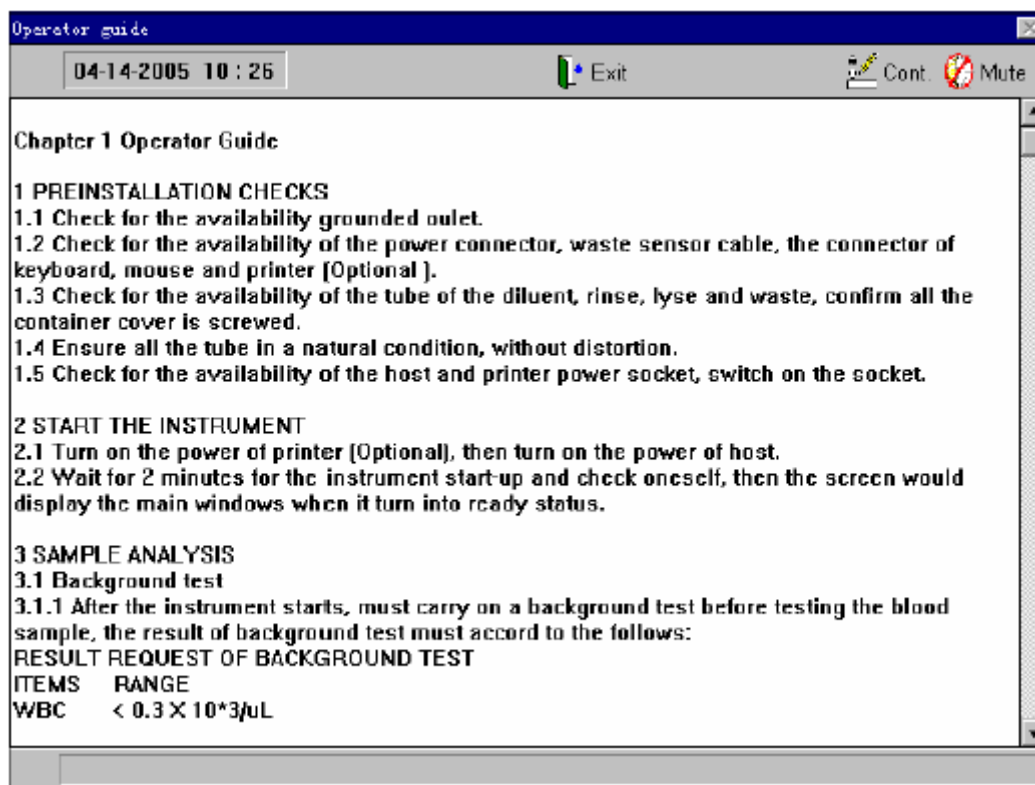

Figure 11-1

This window shows in chapter mode. User can search help information conveniently.

Click the scroll bar up and down, read the information front and back.

Function of the menu and shortcut keys:

Cont.: Select the required contents.

Mute: Get rid of the alarm sound.

Exit: Exit from the current window and return to blood cell analyzer window.

Appendix 1: SYMBOL



Equipotentiality



Notice



Dangerous Voltage



Start Key



Recorder Exit

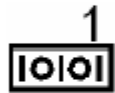

COM 1 Interface

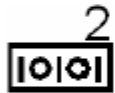

COM 2 Interface



Display Interface



Keyboard Interface



Mouse Interface



Printer Interface



USB Serial Interface